



CENNIK / PRICE LIST



System meble biurowe
biuro@systemmeble.pl
www.systemmeble.pl
tel. 790 536 205

Wykonujemy efektywne miejsca
pracy na terenie całego kraju

POLMARCO

wer.1 2024 obowiązująca od 11.03.2024

CENY NETTO PLN

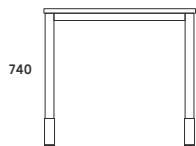

BIURKO PROSTE DUO-C

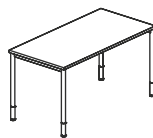
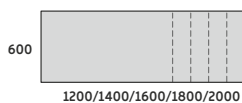

DUO-C 600

CD-P601 1200x600x680-800	746,-
CD-P602 1400x600x680-800	786,-
CD-P603 1600x600x680-800	825,-
CD-P604 1800x600x680-800	862,-
CD-P605 2000x600x680-800	916,-

BIURKO PROSTE DUO-C

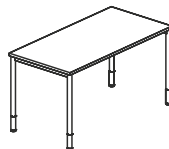
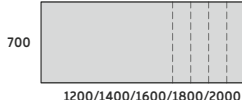

DUO-C 700

CD-P701 1200x700x680-800	771,-
CD-P702 1400x700x680-800	810,-
CD-P703 1600x700x680-800	850,-
CD-P704 1800x700x680-800	889,-
CD-P705 2000x700x680-800	944,-

BIURKO PROSTE DUO-C

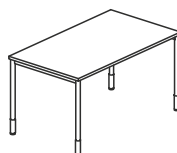
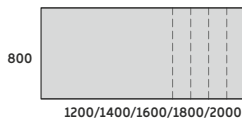

DUO-C 800

CD-P01 1200x800x680-800	810,-
CD-P02 1400x800x680-800	841,-
CD-P03 1600x800x680-800	884,-
CD-P04 1800x800x680-800	926,-
CD-P05 2000x800x680-800	976,-

BIURKO PROSTE DUO-C Z JEDNĄ NOGĄ

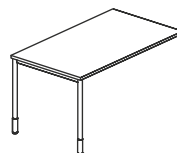
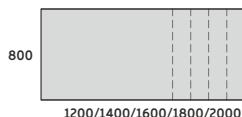

DUO-C 800

CD-P31 1200x800x680-800	804,-
CD-P32 1400x800x680-800	823,-
CD-P33 1600x800x680-800	881,-
CD-P34 1800x800x680-800	924,-
CD-P35 2000x800x680-800	975,-

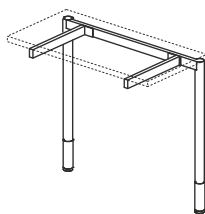

STELAŻ TYPU: DUO-C
PROFIL PIONU: OKRĄGŁY Ø40 MM
PROFIL ŁĄCZNY: 40X20 MM
REGULACJA:
PŁYNNA W ZAKRESIE: 680÷800 MM

DO KONTENERÓW/SZAFEK GABINETOWYCH:
TPS4, TPS4/M, TPS3F, TPS3F/M, TPSP,
DUSP, ADSF, ODSF, UDSF, CDSF
Z KATALOGU KONTENERY

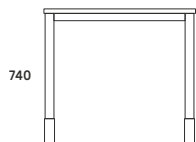

BIURKO NAROŻNE PRAWO DUO-C

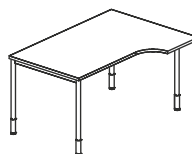
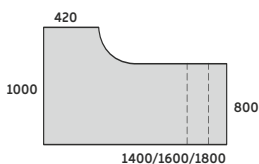

DUO-C NAROŻNE 1000

CD-N11 1400/800x1000/420x680-800	986,-
CD-N14 1600/800x1000/420x680-800	1 049,-
CD-N16 1800/800x1000/420x680-800	1 132,-

BIURKO NAROŻNE LEWO DUO-C

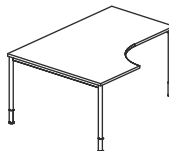
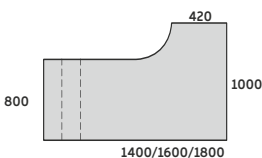

DUO-C NAROŻNE 1000

CD-N12 1400/800x1000/420x680-800	986,-
CD-N15 1600/800x1000/420x680-800	1 049,-
CD-N17 1800/800x1000/420x680-800	1 132,-

BIURKO NAROŻNE PRAWO DUO-C

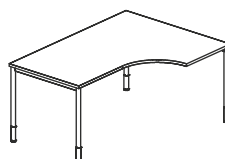
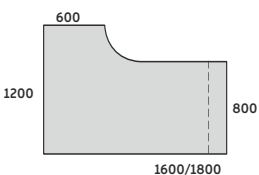

DUO-C NAROŻNE 1200

CD-N21 1600/800x1200/600x680-800	1 189,-
CD-N23 1800/800x1200/600x680-800	1 245,-

BIURKO NAROŻNE LEWO DUO-C

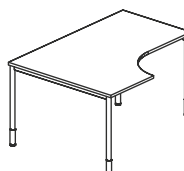
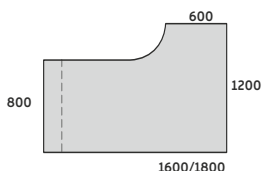

DUO-C NAROŻNE 1200

CD-N22 1600/800x1200/600x680-800	1 189,-
CD-N24 1800/800x1200/600x680-800	1 245,-

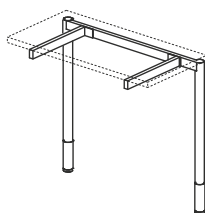

STELAŻ TYPU: DUO-C
PROFIL PIONU: OKRĄGŁY Ø40 MM
PROFIL ŁĄCZNY: 40X20 MM
REGULACJA:
PŁYNNA W ZAKRESIE: 680÷800 MM

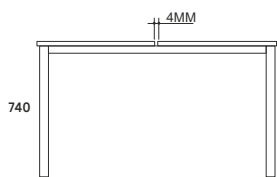

BENCH DUO-C

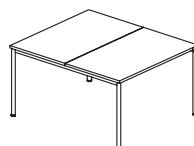

DUO-C 1204

CD-BE1201 1200x1204x740	1 195,-
CD-BE1202 1400x1204x740	1 316,-
CD-BE1203 1600x1204x740	1 359,-
CD-BE1204 1800x1204x740	1 390,-

BENCH DUO-C

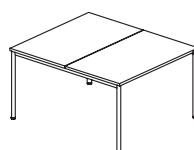
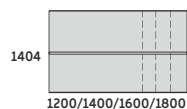

DUO-C 1404

CD-BE1401 1200x1404x740	1 208,-
CD-BE1402 1400x1404x740	1 343,-
CD-BE1403 1600x1404x740	1 387,-
CD-BE1404 1800x1404x740	1 419,-

BENCH DUO-C

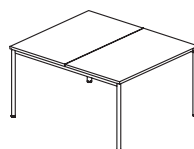
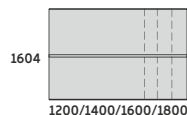

DUO-C 1604

CD-BE1601 1200x1604x740	1 245,-
CD-BE1602 1400x1604x740	1 378,-
CD-BE1603 1600x1604x740	1 415,-
CD-BE1604 1800x1604x740	1 449,-

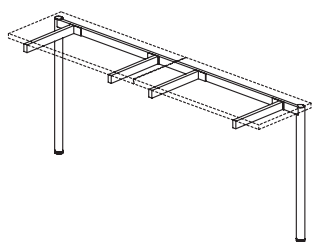

STELAŻ TYPU: DUO-C
PROFIL: OKRĄGŁY Ø40 MM
PROFIL ŁĄCZNY: 40X20 MM
REGULACJA POZIOMUJĄCA: +/- 10 MM
STAŁA WYSOKOŚĆ: 740 MM

MODUŁ ROZSZERZAJĄCY

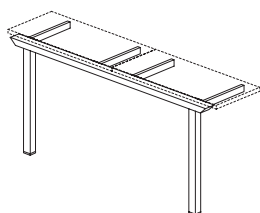

MODUŁ ROZSZERZAJĄCY

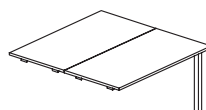
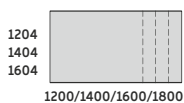

DUO-C 1204

SRBE-1201 1200x1204x740	1 096,-
SRBE-1202 1400x1204x740	1 270,-
SRBE-1203 1600x1204x740	1 300,-
SRBE-1204 1800x1204x740	1 340,-

DUO-C 1404

SRBE-1401 1200x1404x740	1 119,-
SRBE-1402 1400x1404x740	1 292,-
SRBE-1403 1600x1404x740	1 326,-
SRBE-1404 1800x1404x740	1 367,-

DUO-C 1604

SRBE-1601 1200x1604x740	1 147,-
SRBE-1602 1400x1604x740	1 315,-
SRBE-1603 1600x1604x740	1 333,-
SRBE-1604 1800x1604x740	1 388,-

STELAŻ TYPU: DUO-U DO BIUREK BENCH:
DUO-C, DUO-U, DUO-A, DUO-O, DUO-N
PROFIL: KWADRATOWY 40x40 MM
PROFIL ŁĄCZNY: 40X20 MM
REGULACJA POZIOMUJĄCA: +/- 10 MM
STAŁA WYSOKOŚĆ: 740 MM

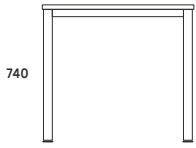

BIURKO PROSTE DUO-U

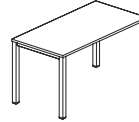
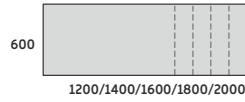

DUO-U 600

UD-P601 1200x600x740	756,-
UD-P602 1400x600x740	792,-
UD-P603 1600x600x740	832,-
UD-P604 1800x600x740	870,-
UD-P605 2000x600x740	904,-

BIURKO PROSTE DUO-U

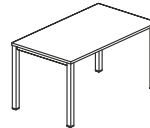
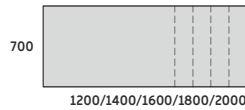

DUO-U 700

UD-P701 1200x700x740	780,-
UD-P702 1400x700x740	818,-
UD-P703 1600x700x740	859,-
UD-P704 1800x700x740	897,-
UD-P705 2000x700x740	932,-

BIURKO PROSTE DUO-U

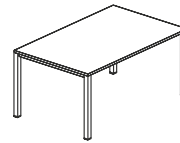
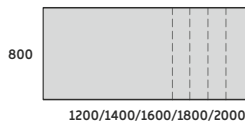

DUO-U 800

UD-P01 1200x800x740	809,-
UD-P02 1400x800x740	851,-
UD-P03 1600x800x740	892,-
UD-P04 1800x800x740	933,-
UD-P05 2000x800x740	978,-

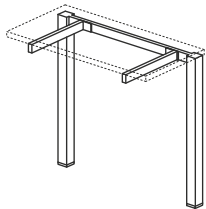

BIURKO PROSTE DUO-U Z JEDNĄ NOGĄ

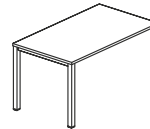
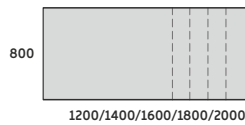

DUO-U 800

UD-P31 1200x800x740	806,-
UD-P32 1400x800x740	849,-
UD-P33 1600x800x740	892,-
UD-P34 1800x800x740	934,-
UD-P35 2000x800x740	978,-

STELAŻ TYPU: DUO-U
PROFIL: KWADRATOWY 50X50 MM
PROFIL ŁĄCZNY: 40X20 MM
REGULACJA:
POZIOMUJĄCA W ZAKRESIE: +/- 10 MM

DO KONTENERÓW/SZAFEK
GABINETOWYCH: TPS4, TPS4/M,
TPS3F, TPS3F/M, TPSP,
DUSP, ADSP, ODSF, UDSP, CDSP
Z KATALOGU KONTENERY

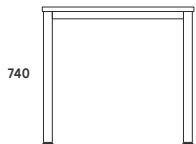

BIURKO NAROŻNE PRAWO DUO-U

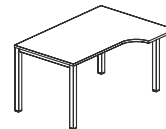
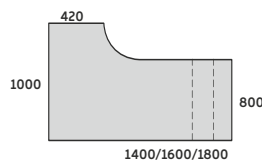

DUO-U NAROŻNE 1000

UD-N11 1400/800x1000/420x740	1 005,-
UD-N14 1600/800x1000/420x740	1 056,-
UD-N16 1800/800x1000/420x740	1 104,-

BIURKO NAROŻNE LEWE DUO-U

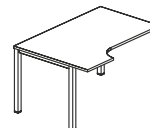
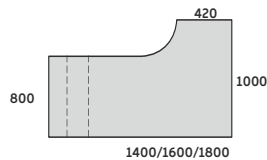

DUO-U NAROŻNE 1000

UD-N12 1400/800x1000/420x740	1 005,-
UD-N15 1600/800x1000/420x740	1 056,-
UD-N17 1800/800x1000/420x740	1 104,-

BIURKO NAROŻNE PRAWO DUO-U

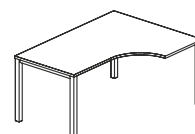
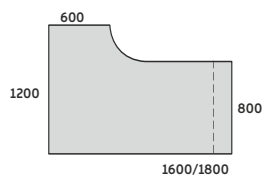

DUO-U NAROŻNE 1200

UD-N21 1600/800x1200/600x740	1 163,-
UD-N23 1800/800x1200/600x740	1 242,-

BIURKO NAROŻNE LEWE DUO-U

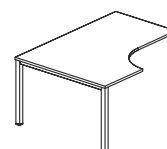
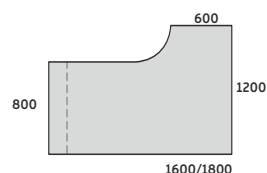

DUO-U NAROŻNE 1200

UD-N22 1600/800x1200/600x740	1 163,-
UD-N24 1800/800x1200/600x740	1 242,-

STELAŻ TYPU: DUO-U
PROFIL: KWADRATOWY 50X50 MM
PROFIL ŁĄCZNY: 40X20 MM
REGULACJA:
POZIOMUJĄCA W ZAKRESIE: +/- 10 MM

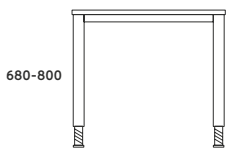

BIURKO PROSTE DUO-U

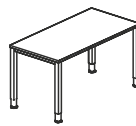
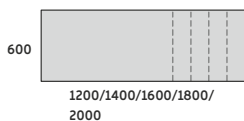

DUO-U 600

UDP-P601 1200x600x680-800	806,-
UDP-P602 1400x600x680-800	846,-
UDP-P603 1600x600x680-800	884,-
UDP-P604 1800x600x680-800	904,-
UDP-P605 2000x600x680-800	944,-

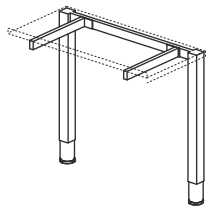

BIURKO PROSTE DUO-U

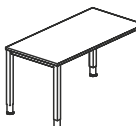
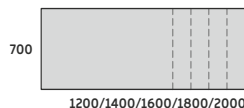

DUO-U 700

UDP-P701 1200x700x680-800	831,-
UDP-P702 1400x700x680-800	872,-
UDP-P703 1600x700x680-800	912,-
UDP-P704 1800x700x680-800	932,-
UDP-P705 2000x700x680-800	973,-

BIURKO PROSTE DUO-U

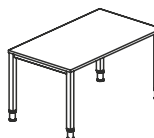
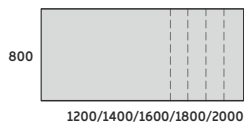

DUO-U 800

UDP-P01 1200x800x680-800	861,-
UDP-P02 1400x800x680-800	903,-
UDP-P03 1600x800x680-800	947,-
UDP-P04 1800x800x680-800	988,-
UDP-P05 2000x800x680-800	1 030,-

STELAŻ TYPU: DUO-U PŁYNNY
PROFIL: KWADRATOWY 50X50 MM
PROFIL ŁĄCZNY: 40X20 MM
REGULACJA:
PŁYNNA W ZAKRESIE: 680=800 MM

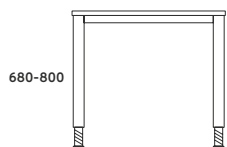

BIURKO NAROŻNE PRAWO DUO-U

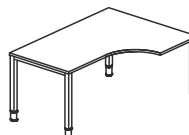
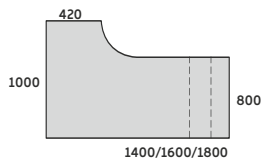

DUO-U NAROŻNE 1000

UDP-N11 1400/800x1000/420x680-800	1 034,-
UDP-N14 1600/800x1000/420x680-800	1 081,-
UDP-N16 1800/800x1000/420x680-800	1 149,-

BIURKO NAROŻNE LEWE DUO-U

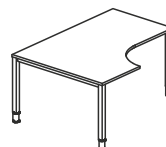
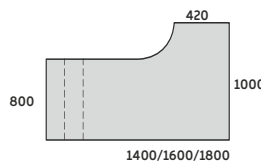

DUO-U NAROŻNE 1000

UDP-N12 1400/800x1000/420x680-800	1 034,-
UDP-N15 1600/800x1000/420x680-800	1 081,-
UDP-N17 1800/800x1000/420x680-800	1 149,-

BIURKO NAROŻNE PRAWO DUO-U

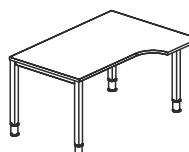
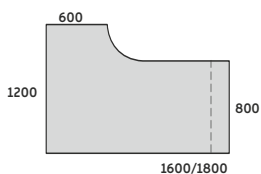

DUO-U NAROŻNE 1200

UDP-N21 1600/800x1200/600x680-800	1 220,-
UDP-N23 1800/800x1200/600x680-800	1 277,-

BIURKO NAROŻNE LEWE DUO-U

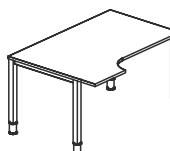
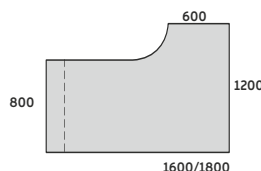

DUO-U NAROŻNE 1200

UDP-N22 1600/800x1200/600x680-800	1 220,-
UDP-N24 1800/800x1200/600x680-800	1 277,-

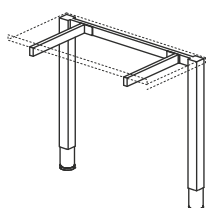

STELAŻ TYPU: DUO-U PŁYNNY
PROFIL: KWADRATOWY 50X50 MM
PROFIL ŁĄCZNY: 40X20 MM
REGULACJA:
PŁYNNA W ZAKRESIE: 680=800 MM

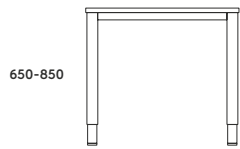

650-850

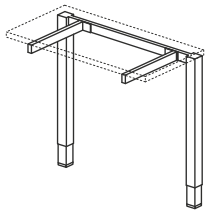

BIURKO PROSTE DUO-U

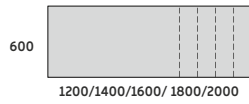

600

1200/1400/1600/1800/2000

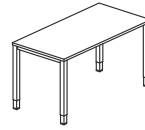

DUO-U 600

UDS-P601 1200x600x650-850	904,-
UDS-P602 1400x600x650-850	942,-
UDS-P603 1600x600x650-850	982,-
UDS-P604 1800x600x650-850	1 020,-
UDS-P605 2000x600x650-850	1 040,-

BIURKO PROSTE DUO-U

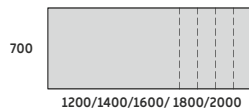

700

1200/1400/1600/1800/2000

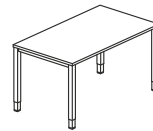

DUO-U 700

UDS-P701 1200x700x650-850	932,-
UDS-P702 1400x700x650-850	973,-
UDS-P703 1600x700x650-850	1 012,-
UDS-P704 1800x700x650-850	1 052,-
UDS-P705 2000x700x650-850	1 073,-

BIURKO PROSTE DUO-U

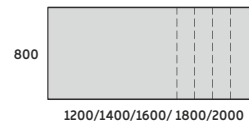

800

1200/1400/1600/1800/2000

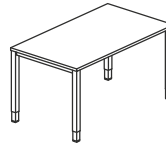

DUO-U 800

UDS-P01 1200x800x650-850	961,-
UDS-P02 1400x800x650-850	1 004,-
UDS-P03 1600x800x650-850	1 046,-
UDS-P04 1800x800x650-850	1 089,-
UDS-P05 2000x800x650-850	1 131,-

STELAŻ TYPU: DUO-U SKOKOWY
PROFIL: KWADRATOWY 50X50 MM
PROFIL ŁĄCZNY: 40X20 MM
REGULACJA:
POZIOMUJĄCA W ZAKRESIE: +/- 10 MM
SKOKOWA W ZAKRESIE: 650÷850 MM
CO 20MM

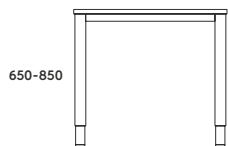

650-850

BIURKO NAROŻNE PRAWO DUO-U

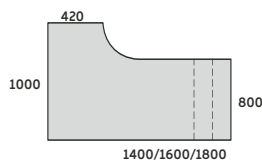

1000

1400/1600/1800

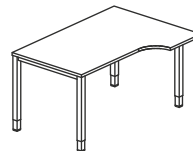

DUO-U NAROŻNE 1000

UDS-N11 1400/800x1000/420x650-850	1 080,-
UDS-N14 1600/800x1000/420x650-850	1 123,-
UDS-N16 1800/800x1000/420x650-850	1 166,-

BIURKO NAROŻNE LEWE DUO-U

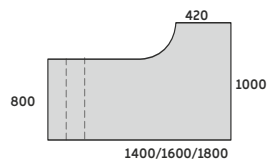

1000

1400/1600/1800

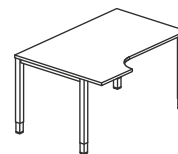

DUO-U NAROŻNE 1000

UDS-N12 1400/800x1000/420x650-850	1 080,-
UDS-N15 1600/800x1000/420x650-850	1 123,-
UDS-N17 1800/800x1000/420x650-850	1 166,-

BIURKO NAROŻNE PRAWO DUO-U

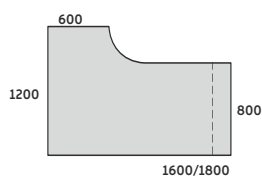

1200

1600/1800

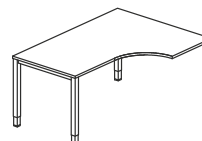

DUO-U NAROŻNE 1200

UDS-N21 1600/800x1200/600x650-850	1 231,-
UDS-N23 1800/800x1200/600x650-850	1 281,-

BIURKO NAROŻNE LEWE DUO-U

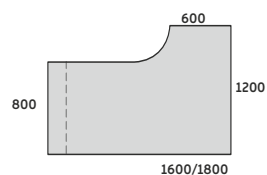

1200

1600/1800

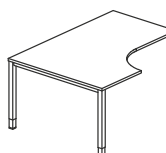

DUO-U NAROŻNE 1200

UDS-N22 1600/800x1200/600x650-850	1 231,-
UDS-N24 1800/800x1200/600x650-850	1 281,-

STELAŻ TYPU: DUO-U SKOKOWY
PROFIL: KWADRATOWY 50X50 MM
PROFIL ŁĄCZNY: 40X20 MM
REGULACJA:
POZIOMUJĄCA W ZAKRESIE: +/- 10 MM
SKOKOWA W ZAKRESIE: 650÷850 MM
CO 20MM

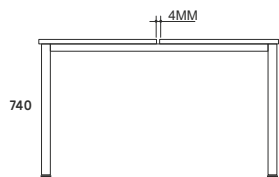

BENCH DUO-U

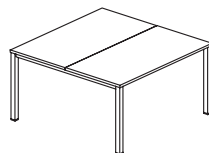
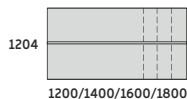

DUO-U 1204

UD-BE1201 1200x1204x740	1 283,-
UD-BE1202 1400x1204x740	1 423,-
UD-BE1203 1600x1204x740	1 450,-
UD-BE1204 1800x1204x740	1 484,-

BENCH DUO-U

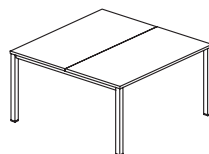
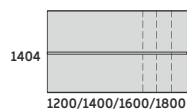

DUO-U 1404

UD-BE1401 1200x1404x740	1 309,-
UD-BE1402 1400x1404x740	1 451,-
UD-BE1403 1600x1404x740	1 488,-
UD-BE1404 1800x1404x740	1 514,-

BENCH DUO-U

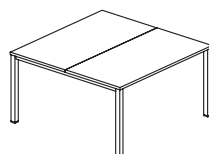
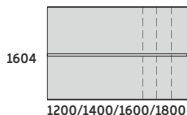

DUO-U 1604

UD-BE1601 1200x1604x740	1 389,-
UD-BE1602 1400x1604x740	1 426,-
UD-BE1603 1600x1604x740	1 461,-
UD-BE1604 1800x1604x740	1 502,-

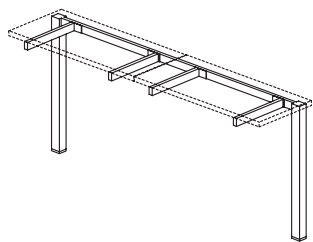

STELAŻ TYPU: DUO-U
PROFIL: KWADRATOWY 50x50 MM
PROFIL ŁĄCZNY: 40x20 MM
REGULACJA POZIOMUJĄCA: +/- 10 MM
STAŁA WYSOKOŚĆ: 740 MM

MODUŁ ROZSZERZAJĄCY

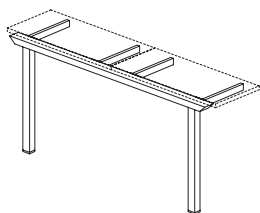

MODUŁ ROZSZERZAJĄCY

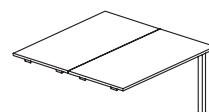
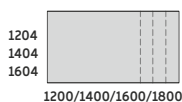

DUO-U 1204

SRBE-1201 1200x1204x740	1 097,-
SRBE-1202 1400x1204x740	1 266,-
SRBE-1203 1600x1204x740	1 299,-
SRBE-1204 1800x1204x740	1 340,-

DUO-U 1404

SRBE-1401 1200x1404x740	1 119,-
SRBE-1402 1400x1404x740	1 292,-
SRBE-1403 1600x1404x740	1 326,-
SRBE-1404 1800x1404x740	1 367,-

DUO-U 1604

SRBE-1601 1200x1604x740	1 147,-
SRBE-1602 1400x1604x740	1 315,-
SRBE-1603 1600x1604x740	1 333,-
SRBE-1604 1800x1604x740	1 388,-

STELAŻ TYPU: DUO-U DO BIUREK
BENCH: DUO-C, DUO-U, DUO-A, DUO-O
PROFIL: KWADRATOWY 40x40 MM
PROFIL ŁĄCZNY: 40x20 MM
REGULACJA POZIOMUJĄCA: +/- 10 MM
STAŁA WYSOKOŚĆ: 740 MM

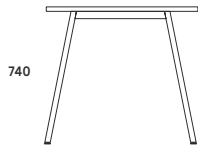

BIURKO PROSTE DUO-A

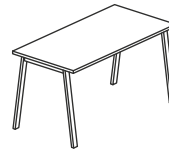
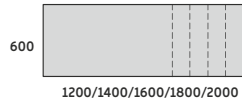

DUO-A 600

AD-P601 1200x600x740	772,-
AD-P602 1400x600x740	812,-
AD-P603 1600x600x740	847,-
AD-P604 1800x600x740	866,-
AD-P605 2000x600x740	922,-

BIURKO PROSTE DUO-A

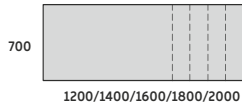

DUO-A 700

AD-P701 1200x700x740	799,-
AD-P702 1400x700x740	839,-
AD-P703 1600x700x740	877,-
AD-P704 1800x700x740	897,-
AD-P705 2000x700x740	955,-

BIURKO PROSTE DUO-A

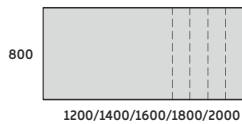

DUO-A 800

AD-P01 1200x800x740	827,-
AD-P02 1400x800x740	869,-
AD-P03 1600x800x740	910,-
AD-P04 1800x800x740	948,-
AD-P05 2000x800x740	988,-

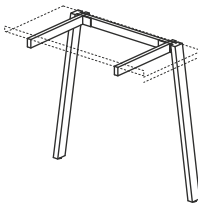

BIURKO PROSTE DUO-A Z JEDNĄ NOGĄ

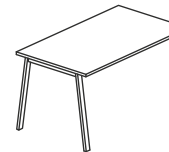
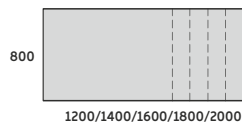

DUO-A 800

AD-P31 1200x800x740	820,-
AD-P32 1400x800x740	863,-
AD-P33 1600x800x740	905,-
AD-P34 1800x800x740	958,-
AD-P35 2000x800x740	998,-

DO KONTENERÓW/SZAFEK
GABINETOWYCH: TPS4, TPS4/M,
TPS3F, TPS3F/M, TPSP,
DUSP, ADSP, ODSP, UDSP, CDSP
Z KATALOGU KONTENERY

STELAŻ TYPU: DUO-A
PROFIL: PROSTOKĄTNY 50X25 MM
PROFIL ŁĄCZNY: 40X20 MM
REGULACJA:
POZIOMUJĄCA W ZAKRESIE: +/- 10 MM

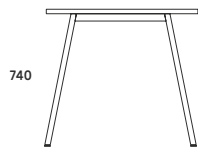

BIURKO NAROŻNE PRAWO DUO-A

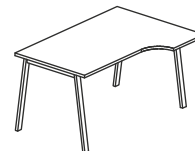
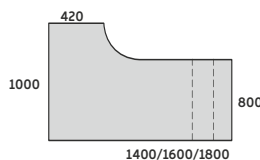

DUO-A NAROŻNE 1000

AD-N11 1400/800x1000/420x740	970,-
AD-N14 1600/800x1000/420x740	1 018,-
AD-N16 1800/800x1000/420x740	1 067,-

BIURKO NAROŻNE LEWE DUO-A

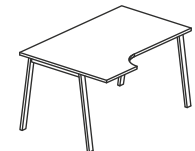
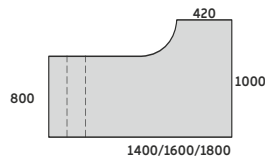

DUO-A NAROŻNE 1000

AD-N12 1400/800x1000/420x740	970,-
AD-N15 1600/800x1000/420x740	1 018,-
AD-N17 1800/800x1000/420x740	1 067,-

BIURKO NAROŻNE PRAWO DUO-A

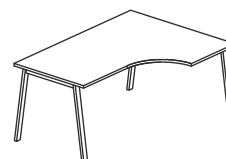
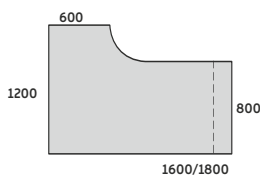

DUO-A NAROŻNE 1200

AD-N21 1600/800x1200/600x740	1 125,-
AD-N23 1800/800x1200/600x740	1 182,-

BIURKO NAROŻNE LEWE DUO-A

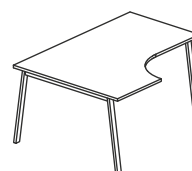
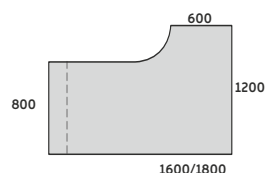

DUO-A NAROŻNE 1200

AD-N22 1600/800x1200/600x740	1 125,-
AD-N24 1800/800x1200/600x740	1 182,-

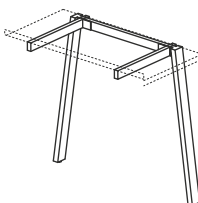

STELAŻ TYPU: DUO-A
PROFIL: PROSTOKĄTNY 50X25 MM
PROFIL ŁĄCZNY: 40X20 MM
REGULACJA:
POZIOMUJĄCA W ZAKRESIE: +/- 10 MM

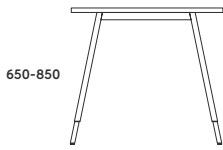

650-850

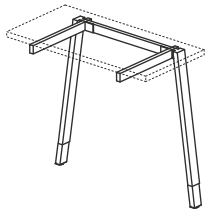

BIURKO PROSTE DUO-A

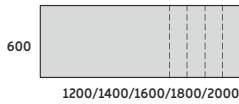

BIURKO PROSTE DUO-A

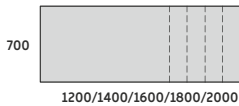

BIURKO PROSTE DUO-A

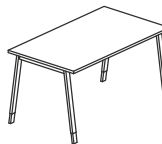
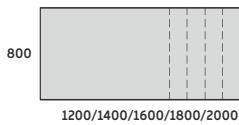

DUO-A 600

ADS-P601 1200x600x650-850	882,-
ADS-P602 1400x600x650-850	916,-
ADS-P603 1600x600x650-850	924,-
ADS-P604 1800x600x650-850	998,-
ADS-P605 2000x600x650-850	1 068,-

DUO-A 700

ADS-P701 1200x700x650-850	911,-
ADS-P702 1400x700x650-850	951,-
ADS-P703 1600x700x650-850	953,-
ADS-P704 1800x700x650-850	1 030,-
ADS-P705 2000x700x650-850	1 103,-

DUO-A 800

ADS-P01 1200x800x650-850	944,-
ADS-P02 1400x800x650-850	983,-
ADS-P03 1600x800x650-850	1 025,-
ADS-P04 1800x800x650-850	1 072,-
ADS-P05 2000x800x650-850	1 106,-

STELAŻ TYPU: DUO-A SKOKOWY
PROFIL: PROSTOKĄTNY 50X25 MM
PROFIL ŁĄCZNYNY: 40X20 MM
REGULACJA:
POZIOMUJĄCA W ZAKRESIE: +/- 10 MM
SKOKOWA W ZAKRESIE: 650÷850 MM
CO 20MM

BIURKO NAROŻNE PRAWY DUO-A

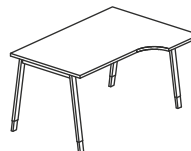
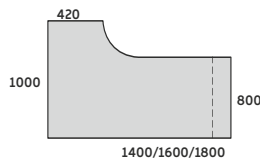

DUO-A NAROŻNE 1000

ADS-N11 1400/800x1000/420x650-850	1 153,-
ADS-N14 1600/800x1000/420x650-850	1 209,-
ADS-N16 1800/800x1000/420x650-850	1 258,-

BIURKO NAROŻNE LEWE DUO-A

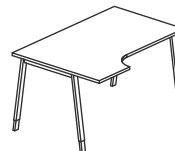
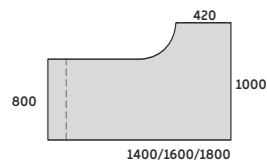

DUO-A NAROŻNE 1000

ADS-N12 1400/800x1000/420x650-850	1 153,-
ADS-N15 1600/800x1000/420x650-850	1 209,-
ADS-N17 1800/800x1000/420x650-850	1 258,-

BIURKO NAROŻNE PRAWY DUO-A

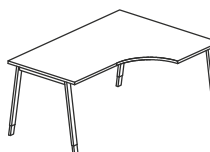
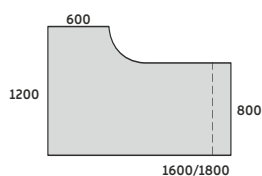

DUO-A NAROŻNE 1200

ADS-N21 1600/800x1200/600x650-850	1 280,-
ADS-N23 1800/800x1200/600x650-850	1 362,-

BIURKO NAROŻNE LEWE DUO-A

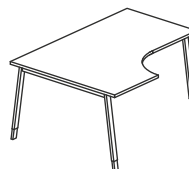
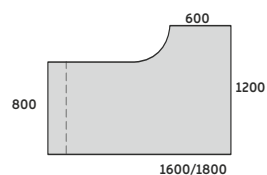

DUO-A NAROŻNE 1200

ADS-N22 1600/800x1200/600x650-850	1 280,-
ADS-N24 1800/800x1200/600x650-850	1 362,-

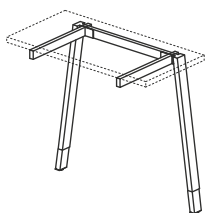

STELAŻ TYPU: DUO-A SKOKOWY
PROFIL: PROSTOKĄTNY 50X25 MM
PROFIL ŁĄCZNYNY: 40X20 MM
REGULACJA:
POZIOMUJĄCA W ZAKRESIE: +/- 10 MM
SKOKOWA W ZAKRESIE: 650÷850 MM
CO 20 MM

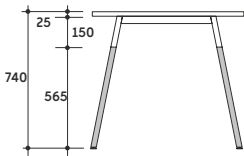

BIURKO PROSTE DUO-A

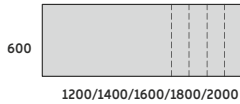

BIURKO PROSTE DUO-A

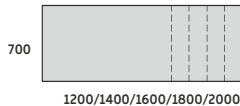

BIURKO PROSTE DUO-A

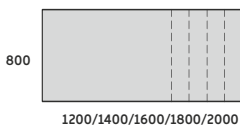

BIURKO PROSTE DUO-A Z JEDNĄ NOGĄ

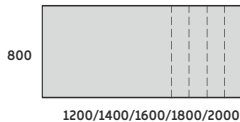

DO KONTENERÓW/SZAFEK
GABINETOWYCH: TPS4, TPS4/M,
TPS3F, TPS3F/M, TPSP,
DUSP, ADSP, ODSF, UDSP, CDSP
Z KATALOGU KONTENERY
**OPCJA Z DOPLATĄ: NOGI
DREWNIANE



DUO-A 600

AD-P601/D 1200x600x740 1 156,-
AD-P602/D 1400x600x740 1 230,-
AD-P604/D 1800x600x740 1 250,-
AD-P605/D 2000x600x740 1 304,-



DUO-A 700

AD-P701/D 1200x700x740 1 180,-
AD-P702/D 1400x700x740 1 220,-
AD-P703/D 1600x700x740 1 258,-
AD-P704/D 1800x700x740 1 278,-
AD-P705/D 2000x700x740 1 336,-



DUO-A 800

AD-P01/D 1200x800x740 1 207,-
AD-P02/D 1400x800x740 1 250,-
AD-P03/D 1600x800x740 1 290,-
AD-P04/D 1800x800x740 1 330,-
AD-P05/D 2000x800x740 1 370,-



DUO-A 800

AD-P31/D 1200x800x740 1 010,-
AD-P32/D 1400x800x740 1 054,-
AD-P33/D 1600x800x740 1 096,-
AD-P34/D 1800x800x740 1 150,-
AD-P35/D 2000x800x740 1 190,-

STELAŻ TYPU: DUO-A
PROFIL: PROSTOKĄTNY 50X25 MM
PROFIL ŁĄCZYNY: 40X20 MM
REGULACJA:
POZIOMUJĄCA W ZAKRESIE: +/- 10 MM

KOLORYSTYKA DREWNA:

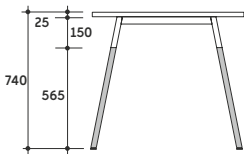

BIURKO NAROŻNE PRAWO DUO-A

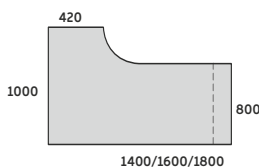

BIURKO NAROŻNE LEWE DUO-A

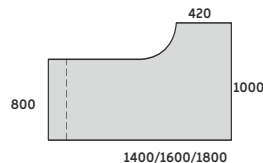

BIURKO NAROŻNE PRAWO DUO-A

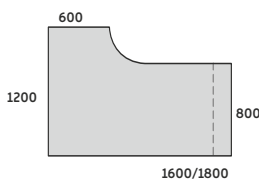

BIURKO NAROŻNE LEWE DUO-A

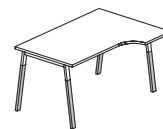
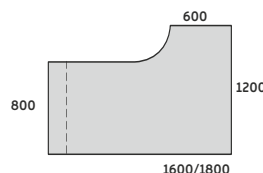

DUO-A NAROŻNE 1000

AD-N11/D 1400/800x1000/420x740 1 350,-
AD-N14/D 1600/800x1000/420x740 1 398,-
AD-N16/D 1800/800x1000/420x740 1 450,-



DUO-A NAROŻNE 1000

AD-N12/D 1400/800x1000/420x740 1 350,-
AD-N15/D 1600/800x1000/420x740 1 398,-
AD-N17/D 1800/800x1000/420x740 1 450,-

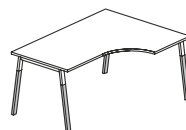

DUO-A NAROŻNE 1200

AD-N21/D 1600/800x1200/600x740 1 506,-
AD-N23/D 1800/800x1200/600x740 1 562,-

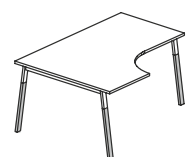

DUO-A NAROŻNE 1200

AD-N22/D 1600/800x1200/600x740 1 506,-
AD-N24/D 1800/800x1200/600x740 1 562,-

STELAŻ TYPU: DUO-A
PROFIL: PROSTOKĄTNY 50X25 MM
PROFIL ŁĄCZYNY: 40X20 MM
REGULACJA:
POZIOMUJĄCA W ZAKRESIE: +/- 10 MM

KOLORYSTYKA DREWNA:



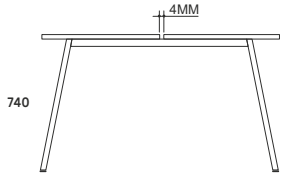

BENCH DUO-A

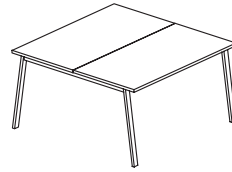
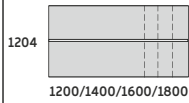

DUO-A 1204

AD-BE1201 1200x1204x740	1 227,-
AD-BE1202 1400x1204x740	1 392,-
AD-BE1203 1600x1204x740	1 428,-
AD-BE1204 1800x1204x740	1 464,-

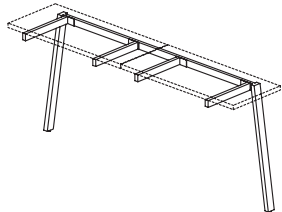

BENCH DUO-A

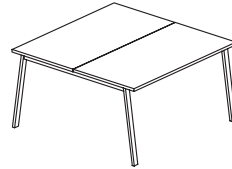
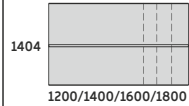

DUO-A 1404

AD-BE1401 1200x1404x740	1 265,-
AD-BE1402 1400x1404x740	1 420,-
AD-BE1403 1600x1404x740	1 472,-
AD-BE1404 1800x1404x740	1 510,-

STELAŻ TYPU: DUO-A
PROFIL: PROSTOKĄTNY 50X25 MM
PROFIL ŁĄCZNYNY: 40X20 MM
REGULACJA:
POZIOMUJĄCA W ZAKRESIE: +/- 10 MM

BENCH DUO-A

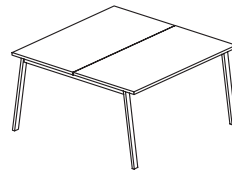
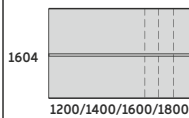

DUO-A 1604

AD-BE1601 1200x1604x740	1 399,-
AD-BE1602 1400x1604x740	1 440,-
AD-BE1603 1600x1604x740	1 484,-
AD-BE1604 1800x1604x740	1 520,-

DUO-A WOOD BENCH

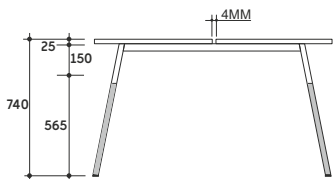

BENCH DUO-A WOOD

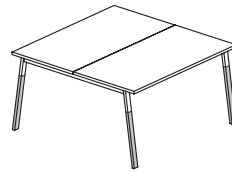
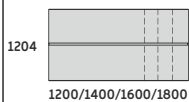

DUO-A 1204

AD-BE1201/D 1200x1204x740	1 607,-
AD-BE1202/D 1400x1204x740	1 772,-
AD-BE1203/D 1600x1204x740	1 805,-
AD-BE1204/D 1800x1204x740	1 844,-

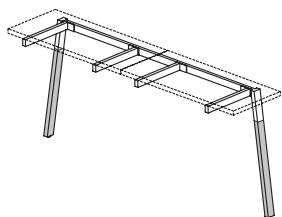

BENCH DUO-A WOOD

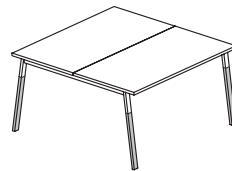
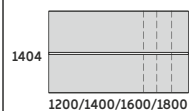

DUO-A 1404

AD-BE1401/D 1200x1404x740	1 645,-
AD-BE1402/D 1400x1404x740	1 800,-
AD-BE1403/D 1600x1404x740	1 852,-
AD-BE1404/D 1800x1404x740	1 890,-

STELAŻ TYPU: DUO-A
PROFIL: PROSTOKĄTNY 50X25 MM
PROFIL ŁĄCZNYNY: 40X20 MM
REGULACJA:
POZIOMUJĄCA W ZAKRESIE: +/- 10 MM

BENCH DUO-A WOOD

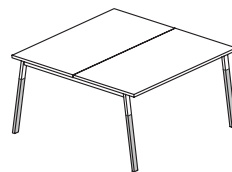
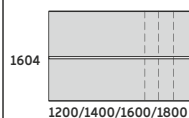

DUO-A 1604

AD-BE1601/D 1200x1604x740	1 779,-
AD-BE1602/D 1400x1604x740	1 820,-
AD-BE1603/D 1600x1604x740	1 864,-
AD-BE1604/D 1800x1604x740	1 900,-

MODUŁ ROZSZERZAJĄCY

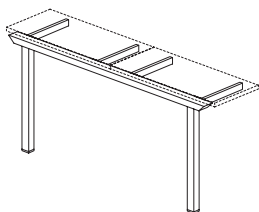

MODUŁ ROZSZERZAJĄCY

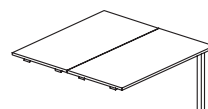
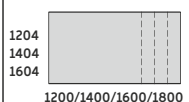

DUO-A 1204

SRBE-1201 1200x1204x740	1 085,-
SRBE-1202 1400x1204x740	1 253,-
SRBE-1203 1600x1204x740	1 286,-
SRBE-1204 1800x1204x740	1 326,-

DUO-A 1404

SRBE-1401 1200x1404x740	1 119,-
SRBE-1402 1400x1404x740	1 292,-
SRBE-1403 1600x1404x740	1 326,-
SRBE-1404 1800x1404x740	1 367,-

DUO-A 1604

SRBE-1601 1200x1604x740	1 147,-
SRBE-1602 1400x1604x740	1 315,-
SRBE-1603 1600x1604x740	1 333,-
SRBE-1604 1800x1604x740	1 388,-

STELAŻ TYPU: DUO-U DO BIUREK BENCH:
DUO-C, DUO-U, DUO-A, DUO-O, DUO-N
PROFIL: KWADRATOWY 40x40 MM PROFIL
ŁĄCZNYNY: 40X20 MM REGULACJA
POZIOMUJĄCA: +/- 10 MM STAŁA
WYSOKOŚĆ: 740 MM

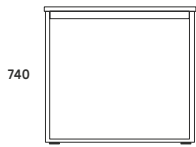

740

BIURKO PROSTE DUO-O

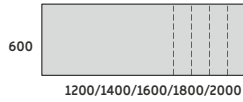

600

1200/1400/1600/1800/2000

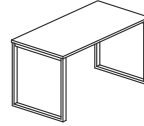

DUO-O 600

OD-P601 1200x600x740	845,-
OD-P602 1400x600x740	889,-
OD-P603 1600x600x740	926,-
OD-P604 1800x600x740	964,-
OD-P605 2000x600x740	999,-

BIURKO PROSTE DUO-O

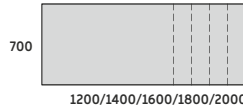

700

1200/1400/1600/1800/2000

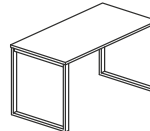

DUO-O 700

OD-P701 1200x700x740	863,-
OD-P702 1400x700x740	907,-
OD-P703 1600x700x740	945,-
OD-P704 1800x700x740	984,-
OD-P705 2000x700x740	1 021,-

BIURKO PROSTE DUO-O

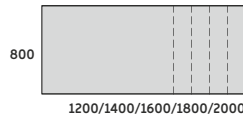

800

1200/1400/1600/1800/2000

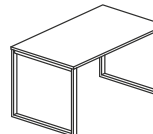

DUO-O 800

OD-P01 1200x800x740	895,-
OD-P02 1400x800x740	941,-
OD-P03 1600x800x740	982,-
OD-P04 1800x800x740	1 023,-
OD-P05 2000x800x740	1 060,-

BIURKO PROSTE DUO-O Z JEDNĄ NOGĄ

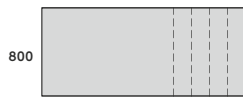

800

1200/1400/1600/1800/2000

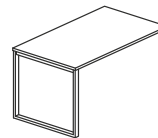

DUO-O 800

OD-P31 1200x800x740	805,-
OD-P32 1400x800x740	850,-
OD-P33 1600x800x740	887,-
OD-P34 1800x800x740	928,-
OD-P35 2000x800x740	967,-

DO KONTENERÓW/SZAFEK
GABINETOWYCH: TPS4, TPS4/M,
TPS3F, TPS3F/M, TPSP,
DUSP, ADSP, ODSP, UDSP, CDSP
Z KATALOGU KONTENERY

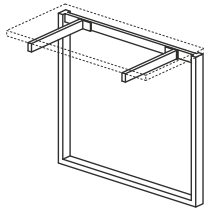

STELAŻ TYPU: DUO-O
PROFIL: PROSTOKĄTNY 50X25 MM
PROFIL ŁĄCZNY: 40X20 MM
REGULACJA:
POZIOMUJĄCA W ZAKRESIE: +/- 10 MM

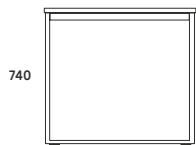

740

BIURKO NAROŻNE PRAWO DUO-O

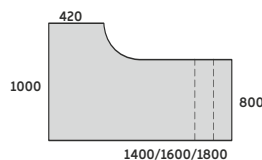

1000

1400/1600/1800

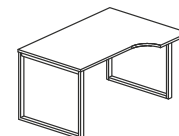

DUO-O NAROŻNE 1000

OD-N11 1400/800x1000/420x740	1 087,-
OD-N14 1600/800x1000/420x740	1 135,-
OD-N16 1800/800x1000/420x740	1 184,-

BIURKO NAROŻNE LEWE DUO-O

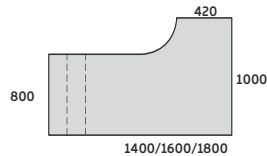

800

1400/1600/1800

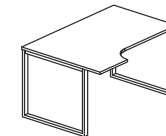

DUO-O NAROŻNE 1000

OD-N12 1400/800x1000/420x740	1 087,-
OD-N15 1600/800x1000/420x740	1 135,-
OD-N17 1800/800x1000/420x740	1 184,-

BIURKO NAROŻNE PRAWO DUO-O

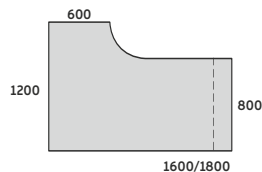

1200

1600/1800

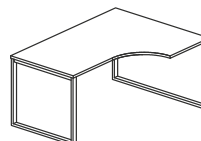

DUO-O NAROŻNE 1200

OD-N21 1600/800x1200/600x740	1 265,-
OD-N23 1800/800x1200/600x740	1 322,-

BIURKO NAROŻNE LEWE DUO-O

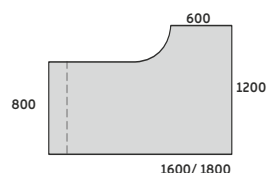

800

1600/1800

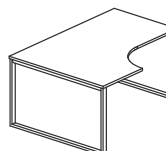

DUO-O NAROŻNE 1200

OD-N22 1600/800x1200/600x740	1 265,-
OD-N24 1800/800x1200/600x740	1 322,-

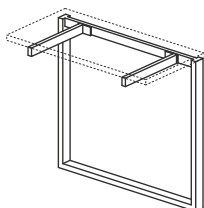

STELAŻ TYPU: DUO-O
PROFIL: PROSTOKĄTNY 50X25 MM
PROFIL ŁĄCZNY: 40X20 MM
REGULACJA:
POZIOMUJĄCA W ZAKRESIE: +/- 10 MM

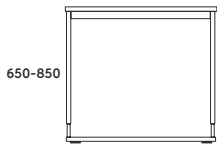

BIURKO PROSTE DUO-O

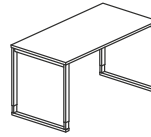
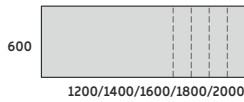

DUO-O 600

ODS-P601 1200x600x650-850	965,-
ODS-P602 1400x600x650-850	1 024,-
ODS-P603 1600x600x650-850	1 055,-
ODS-P604 1800x600x650-850	1 094,-
ODS-P605 2000x600x650-850	1 134,-

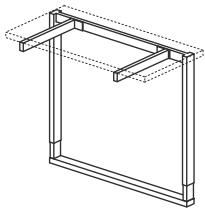

BIURKO PROSTE DUO-O

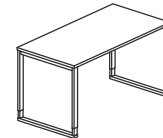
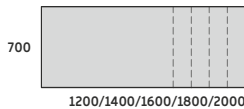

DUO-O 700

ODS-P701 1200x700x650-850	995,-
ODS-P702 1400x700x650-850	1 056,-
ODS-P703 1600x700x650-850	1 088,-
ODS-P704 1800x700x650-850	1 128,-
ODS-P705 2000x700x650-850	1 169,-

BIURKO PROSTE DUO-O

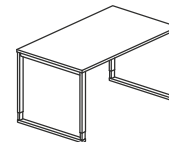
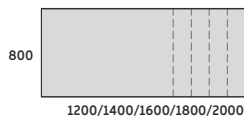

DUO-O 800

ODS-P01 1200x800x650-850	1 046,-
ODS-P02 1400x800x650-850	1 089,-
ODS-P03 1600x800x650-850	1 133,-
ODS-P04 1800x800x650-850	1 174,-
ODS-P05 2000x800x650-850	1 214,-

STELAŻ TYPU: DUO-O SKOKOWY
PROFIL: PROSTOKĄTNY 50X25 MM
PROFIL ŁĄCZNYNY: 40X20 MM
REGULACJA:
POZIOMUJĄCA W ZAKRESIE: +/- 10 MM
SKOKOWA W ZAKRESIE: 650÷850 MM
CO 20MM

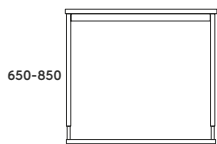

BIURKO NAROŻNE PRAWO DUO-O

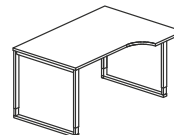
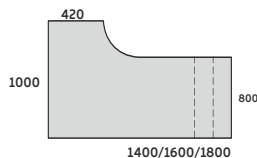

DUO-O NAROŻNE 1000

ODS-N11 1400/800x1000/420x650-850	1 213,-
ODS-N14 1600/800x1000/420x650-850	1 261,-
ODS-N16 1800/800x1000/420x650-850	1 310,-

BIURKO NAROŻNE LEWE DUO-O

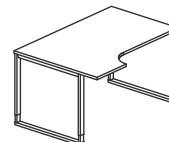
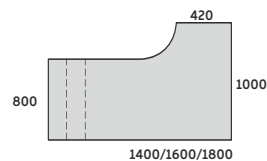

DUO-O NAROŻNE 1000

ODS-N12 1400/800x1000/420x650-850	1 213,-
ODS-N15 1600/800x1000/420x650-850	1 261,-
ODS-N17 1800/800x1000/420x650-850	1 310,-

BIURKO NAROŻNE PRAWO DUO-O

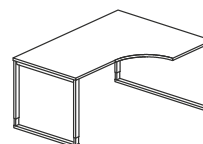
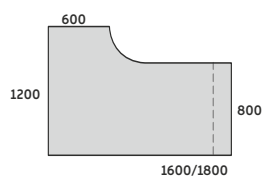

DUO-O NAROŻNE 1200

ODS-N21 1600/800x1200/600x650-850	1 391,-
ODS-N23 1800/800x1200/600x650-850	1 447,-

BIURKO NAROŻNE LEWE DUO-O

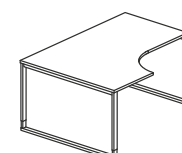
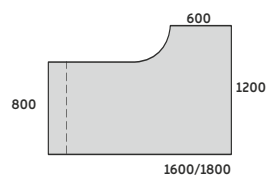

DUO-O NAROŻNE 1200

ODS-N22 1600/800x1200/600x650-850	1 391,-
ODS-N24 1800/800x1200/600x650-850	1 447,-

STELAŻ TYPU: DUO-O SKOKOWY
PROFIL: PROSTOKĄTNY 50X25 MM
PROFIL ŁĄCZNYNY: 40X20 MM
REGULACJA:
POZIOMUJĄCA W ZAKRESIE: +/- 10 MM
SKOKOWA W ZAKRESIE: 650÷850 MM
CO 20MM

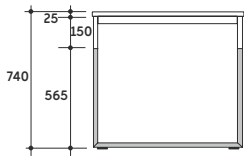

BIURKO PROSTE DUO-O

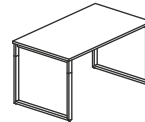
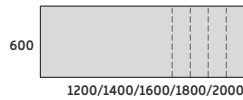

DUO-O 600

OD-P601/D 1200x600x740	1 333,-
OD-P602/D 1400x600x740	1 377,-
OD-P603/D 1600x600x740	1 414,-
OD-P604/D 1800x600x740	1 452,-
OD-P605/D 2000x600x740	1 487,-

BIURKO PROSTE DUO-O

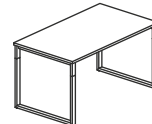
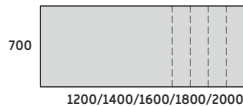

DUO-O 700

OD-P701/D 1200x700x740	1 351,-
OD-P702/D 1400x700x740	1 395,-
OD-P703/D 1600x700x740	1 433,-
OD-P704/D 1800x700x740	1 472,-
OD-P705/D 2000x700x740	1 509,-

BIURKO PROSTE DUO-O

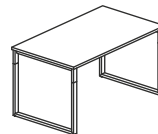
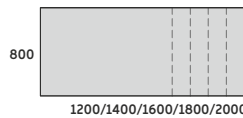

DUO-O 800

OD-P01/D 1200x800x740	1 383,-
OD-P02/D 1400x800x740	1 429,-
OD-P03/D 1600x800x740	1 470,-
OD-P04/D 1800x800x740	1 511,-
OD-P05/D 2000x800x740	1 548,-

BIURKO PROSTE DUO-O Z JEDNĄ NOGĄ

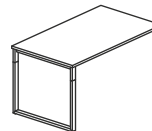
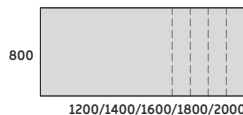

DUO-O 800

OD-P31/D 1200x800x740	1 052,-
OD-P32/D 1400x800x740	1 096,-
OD-P33/D 1600x800x740	1 133,-
OD-P34/D 1800x800x740	1 174,-
OD-P35/D 2000x800x740	1 213,-

DO KONTENERÓW/SZAFEK GABINETOWYCH:
TPS4, TPS4/M, TPS3F, TPS3F/M, TPSP,
DUSP, ADSP, ODSP, UDSP, CDSP
Z KATALOGU KONTENERY
**OPCJA Z DOPŁATĄ: NOGI DREWNIANE

STELAŻ TYPU: DUO-O
PROFIL: PROSTOKĄTNY 50X25 MM
PROFIL ŁĄCZNY: 40X20 MM
REGULACJA:
POZIOMUJĄCA W ZAKRESIE: +/- 10 MM

KOLORYSTYKA DREWNA:

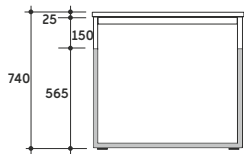

BIURKO NAROŻNE PRAWO DUO-O

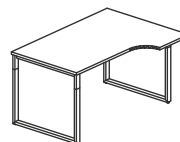
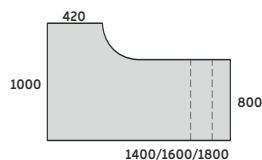

DUO-O NAROŻNE 1000

OD-N11/D 1400/800x1000/420x740	1 572,-
OD-N14/D 1600/800x1000/420x740	1 623,-
OD-N16/D 1800/800x1000/420x740	1 672,-

BIURKO NAROŻNE LEWE DUO-O

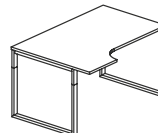
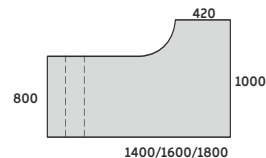

DUO-O NAROŻNE 1000

OD-N12/D 1400/800x1000/420x740	1 572,-
OD-N15/D 1600/800x1000/420x740	1 623,-
OD-N17/D 1800/800x1000/420x740	1 672,-

BIURKO NAROŻNE PRAWO DUO-O

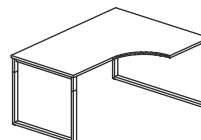
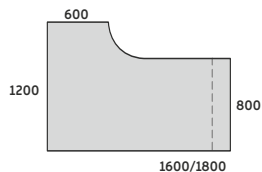

DUO-O NAROŻNE 1200

OD-N21/D 1600/800x1200/600x740	1 800,-
OD-N23/D 1800/800x1200/600x740	1 858,-

BIURKO NAROŻNE LEWE DUO-O

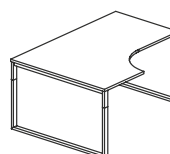
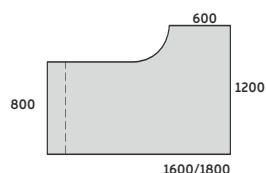

DUO-O NAROŻNE 1200

OD-N22/D 1600/800x1200/600x740	1 800,-
OD-N24/D 1800/800x1200/600x740	1 858,-

STELAŻ TYPU: DUO-O
PROFIL: PROSTOKĄTNY 50X25 MM
PROFIL ŁĄCZNY: 40X20 MM
REGULACJA:
POZIOMUJĄCA W ZAKRESIE: +/- 10 MM

KOLORYSTYKA DREWNA:



BENCH

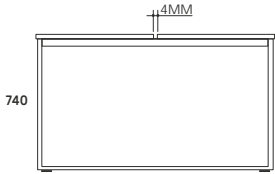

BENCH DUO-O

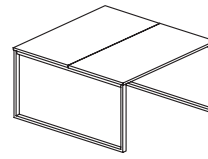
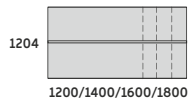

DUO-O 1204

OD-BE1201 1200x1204x740	1 345,-
OD-BE1202 1400x1204x740	1 497,-
OD-BE1203 1600x1204x740	1 537,-
OD-BE1204 1800x1204x740	1 574,-

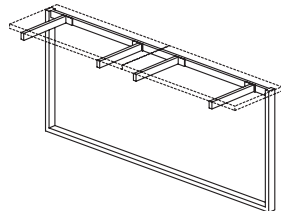

BENCH DUO-O

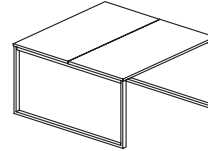
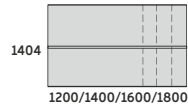

DUO-O 1404

OD-BE1401 1200x1404x740	1 359,-
OD-BE1402 1400x1404x740	1 528,-
OD-BE1403 1600x1404x740	1 568,-
OD-BE1404 1800x1404x740	1 607,-

BENCH DUO-O

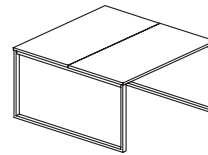
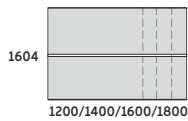

DUO-O 1604

OD-BE1601 1200x1604x740	1 560,-
OD-BE1602 1400x1604x740	1 600,-
OD-BE1603 1600x1604x740	1 635,-
OD-BE1604 1800x1604x740	1 679,-

STELAŻ TYPU: DUO-O
PROFIL: PROSTOKĄTNY 50X25 MM
PROFIL ŁĄCZNY: 40X20 MM
REGULACJA:
POZIOMUJĄCA W ZAKRESIE: +/- 10 MM

DUO-O

WOOD BENCH

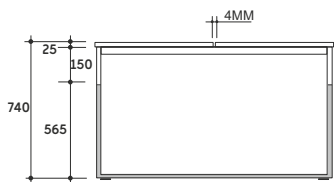

BENCH DUO-O WOOD

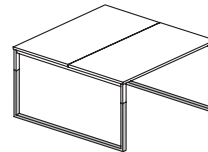
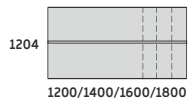

DUO-O 1204

OD-BE1201/D 1200x1204x740	1 945,-
OD-BE1202/D 1400x1204x740	2 097,-
OD-BE1203/D 1600x1204x740	2 137,-
OD-BE1204/D 1800x1204x740	2 174,-

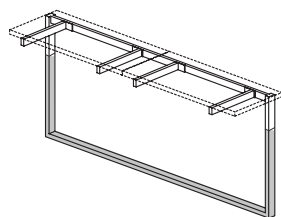

BENCH DUO-O WOOD

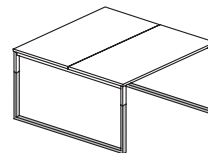
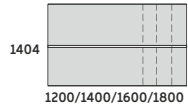

DUO-O 1404

OD-BE1401/D 1200x1404x740	1 959,-
OD-BE1402/D 1400x1404x740	2 130,-
OD-BE1403/D 1600x1404x740	2 170,-
OD-BE1404/D 1800x1404x740	2 207,-

BENCH DUO-O WOOD

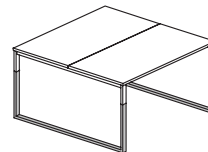
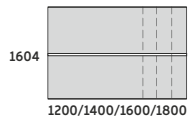

DUO-O 1604

OD-BE1601/D 1200x1604x740	2 160,-
OD-BE1602/D 1400x1604x740	2 200,-
OD-BE1603/D 1600x1604x740	2 240,-
OD-BE1604/D 1800x1604x740	2 280,-

STELAŻ TYPU: DUO-O
PROFIL: PROSTOKĄTNY 50X25 MM
PROFIL ŁĄCZNY: 40X20 MM
REGULACJA:
POZIOMUJĄCA W ZAKRESIE: +/- 10 MM

MODUŁ ROZSZERZAJĄCY

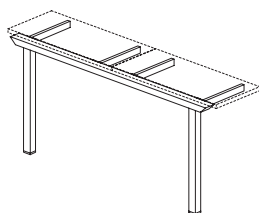

MODUŁ ROZSZERZAJĄCY

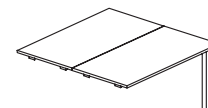
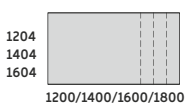

DUO-O 1204

SRBE-1201 1200x1204x740	1 097,-
SRBE-1202 1400x1204x740	1 266,-
SRBE-1203 1600x1204x740	1 300,-
SRBE-1204 1800x1204x740	1 340,-

DUO-O 1404

SRBE-1401 1200x1404x740	1 119,-
SRBE-1402 1400x1404x740	1 292,-
SRBE-1403 1600x1404x740	1 326,-
SRBE-1404 1800x1404x740	1 367,-

DUO-O 1604

SRBE-1601 1200x1604x740	1 147,-
SRBE-1602 1400x1604x740	1 315,-
SRBE-1603 1600x1604x740	1 333,-
SRBE-1604 1800x1604x740	1 388,-

STELAŻ TYPU: DUO-U DO BIUREK BENCH:
DUO-C, DUO-U, DUO-A, DUO-O, DUO-N
PROFIL: KWADRATOWY 40x40 MM
PROFIL ŁĄCZNY: 40X20 MM
REGULACJA POZIOMUJĄCA: +/- 10 MM
STAŁA WYSOKOŚĆ: 740 MM

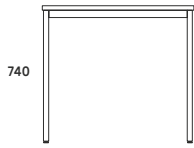

BIURKO PROSTE DUO-N

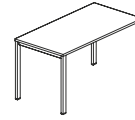
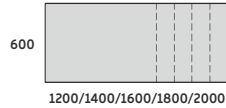

DUO-N 600

ND-P601 1200x600x740	764,-
ND-P602 1400x600x740	802,-
ND-P603 1600x600x740	841,-
ND-P604 1800x600x740	880,-
ND-P605 2000x600x740	914,-

BIURKO PROSTE DUO-N

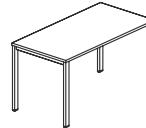
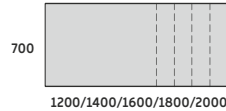

DUO-N 700

ND-P701 1200x700x740	772,-
ND-P702 1400x700x740	810,-
ND-P703 1600x700x740	850,-
ND-P704 1800x700x740	888,-
ND-P705 2000x700x740	923,-

BIURKO PROSTE DUO-N

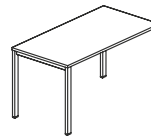
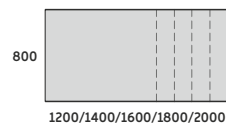

DUO-N 800

ND-P01 1200x800x740	801,-
ND-P02 1400x800x740	843,-
ND-P03 1600x800x740	884,-
ND-P04 1800x800x740	924,-
ND-P05 2000x800x740	968,-

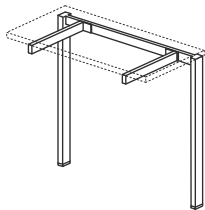

BIURKO PROSTE DUO-N Z JEDNĄ NOGĄ

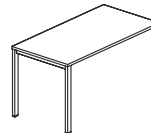
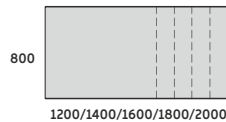

DUO-N 800

ND-P31 1200x800x740	797,-
ND-P32 1400x800x740	839,-
ND-P33 1600x800x740	879,-
ND-P34 1800x800x740	918,-
ND-P35 2000x800x740	962,-

STELAŻ TYPU: DUO-N
PROFIL: PROSTOKĄTNY 50X25 MM
PROFIL ŁĄCZYNY: 40X20 MM
REGULACJA:
POZIOMUJĄCA W ZAKRESIE: +/- 10 MM

DO KONTENERÓW/SZAFEK GABINETOWYCH:
TPS4, TPS4/M, TPS3F, TPS3F/M, TPSP,
DUSP, ADSP, ODSF, UDSP, CDSP
Z KATALOGU KONTENERY

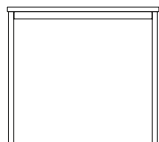

BIURKO NAROŻNE PRAWO DUO-N

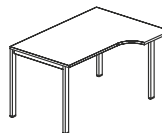
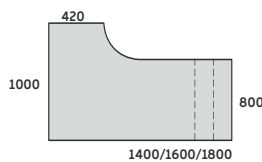

DUO-N NAROŻNE 1000

ND-N11 1400/800x1000/420x740	995,-
ND-N14 1600/800x1000/420x740	1 046,-
ND-N16 1800/800x1000/420x740	1 092,-

BIURKO NAROŻNE LEWE DUO-N

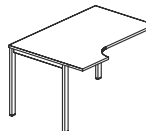
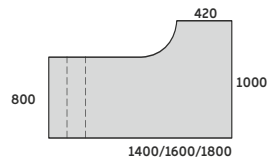

DUO-N NAROŻNE 1000

ND-N12 1400/800x1000/420x740	995,-
ND-N15 1600/800x1000/420x740	1 046,-
ND-N17 1800/800x1000/420x740	1 092,-

BIURKO NAROŻNE PRAWO DUO-N

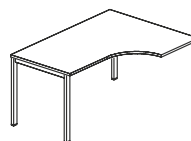
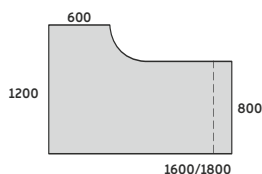

DUO-N NAROŻNE 1200

ND-N21 1600/800x1200/600x740	1 152,-
ND-N23 1800/800x1200/600x740	1 230,-

BIURKO NAROŻNE LEWE DUO-N

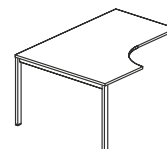
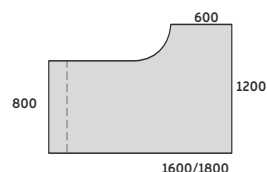

DUO-N NAROŻNE 1200

ND-N22 1600/800x1200/600x740	1 152,-
ND-N24 1800/800x1200/600x740	1 230,-

STELAŻ TYPU: DUO-N
PROFIL: PROSTOKĄTNY 50X25 MM
PROFIL ŁĄCZYNY: 40X20 MM
REGULACJA:
POZIOMUJĄCA W ZAKRESIE: +/- 10 MM

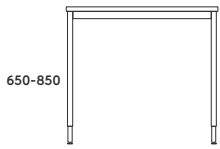

BIURKO PROSTE DUO-N

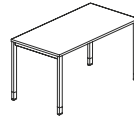
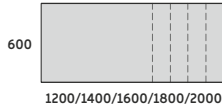

DUO-N 600

NDS-P601	1200x600x650-850	915,-
NDS-P602	1400x600x650-850	955,-
NDS-P603	1600x600x650-850	994,-
NDS-P604	1800x600x650-850	1 036,-
NDS-P605	2000x600x650-850	1 054,-

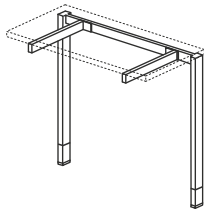

BIURKO PROSTE DUO-N

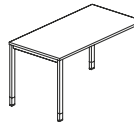
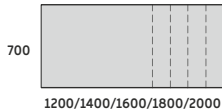

DUO-N 700

NDS-P701	1200x700x650-850	923,-
NDS-P702	1400x700x650-850	964,-
NDS-P703	1600x700x650-850	1 002,-
NDS-P704	1800x700x650-850	1 042,-
NDS-P705	2000x700x650-850	1 062,-

STELAŻ TYPU: DUO-N SKOKOWY
PROFIL: PROSTOKĄTNY 50X25 MM
PROFIL ŁĄCZYNY: 40X20 MM
REGULACJA:
POZIOMUJĄCA W ZAKRESIE: +/- 10 MM
SKOKOWA W ZAKRESIE: 650÷850 MM
CO 20MM

BIURKO PROSTE DUO-N

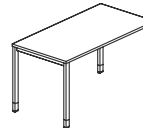
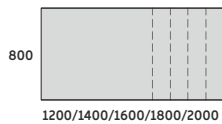

DUO-N 800

NDS-P01	1200x800x650-850	952,-
NDS-P02	1400x800x650-850	994,-
NDS-P03	1600x800x650-850	1 036,-
NDS-P04	1800x800x650-850	1 078,-
NDS-P05	2000x800x650-850	1 120,-

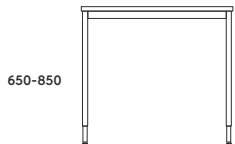

BIURKO NAROŻNE PRAWO DUO-N

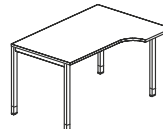
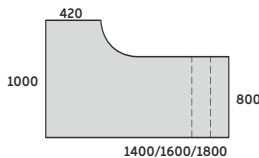

DUO-N NAROŻNE 1000

NDS-N11	1400/800x1000/420x650-850	1 080,-
NDS-N14	1600/800x1000/420x650-850	1 123,-
NDS-N16	1800/800x1000/420x650-850	1 166,-

BIURKO NAROŻNE LEWE DUO-N

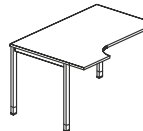
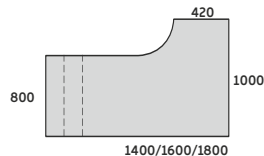

DUO-N NAROŻNE 1000

NDS-N12	1400/800x1000/420x650-850	1 080,-
NDS-N15	1600/800x1000/420x650-850	1 123,-
NDS-N17	1800/800x1000/420x650-850	1 166,-

BIURKO NAROŻNE PRAWO DUO-N

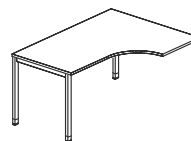
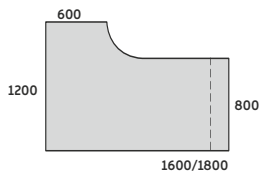

DUO-N NAROŻNE 1200

NDS-N21	1600/800x1200/600x650-850	1 231,-
NDS-N23	1800/800x1200/600x650-850	1 281,-

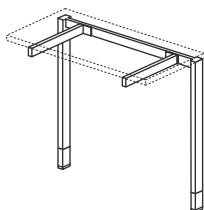

BIURKO NAROŻNE LEWE DUO-N

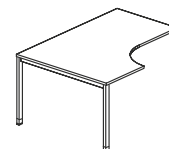
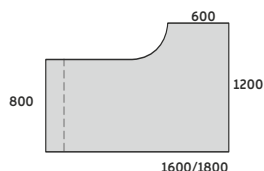

DUO-N NAROŻNE 1200

NDS-N22	1600/800x1200/600x650-850	1 231,-
NDS-N24	1800/800x1200/600x650-850	1 281,-

STELAŻ TYPU: DUO-N SKOKOWY
PROFIL: PROSTOKĄTNY 50X25 MM
PROFIL ŁĄCZYNY: 40X20 MM
REGULACJA:
POZIOMUJĄCA W ZAKRESIE: +/- 10 MM
SKOKOWA W ZAKRESIE: 650÷850 MM
CO 20MM

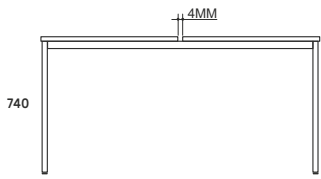

BENCH DUO-N

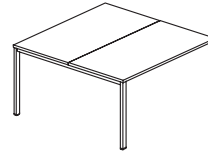
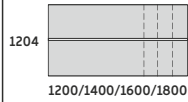

DUO-N 1204

ND-BE1201 1200x1204x740	1 340,-
ND-BE1202 1400x1204x740	1 424,-
ND-BE1203 1600x1204x740	1 460,-
ND-BE1204 1800x1204x740	1 485,-

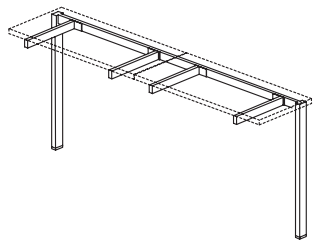

BENCH DUO-N

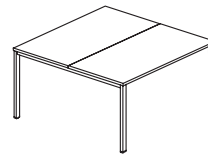
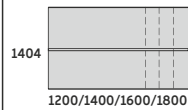

DUO-N 1404

ND-BE1401 1200x1404x740	1 296,-
ND-BE1402 1400x1404x740	1 436,-
ND-BE1403 1600x1404x740	1 473,-
ND-BE1404 1800x1404x740	1 499,-

BENCH DUO-N

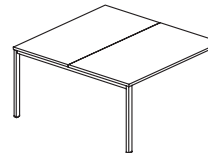
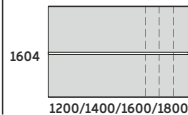

DUO-N 1604

ND-BE1601 1200x1604x740	1 347,-
ND-BE1602 1400x1604x740	1 409,-
ND-BE1603 1600x1604x740	1 517,-
ND-BE1604 1800x1604x740	1 544,-

STELAŻ TYPU: DUO-N
PROFIL: PROSTOKĄTNY 50X25 MM
PROFIL ŁĄCZYNY: 40X20 MM
REGULACJA:
POZIOMUJĄCA W ZAKRESIE: +/- 10 MM

MODUŁ ROZSZERZAJĄCY

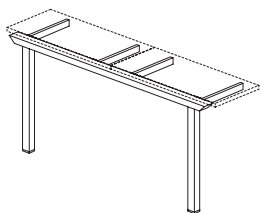

MODUŁ ROZSZERZAJĄCY

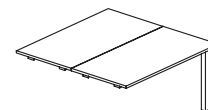
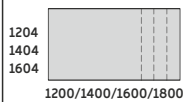

DUO-N 1204

SRBE-1201 1200x1204x740	1 110,-
SRBE-1202 1400x1204x740	1 280,-
SRBE-1203 1600x1204x740	1 314,-
SRBE-1204 1800x1204x740	1 353,-

DUO-N 1404

SRBE-1401 1200x1404x740	1 119,-
SRBE-1402 1400x1404x740	1 292,-
SRBE-1403 1600x1404x740	1 326,-
SRBE-1404 1800x1404x740	1 367,-

DUO-N 1604

SRBE-1601 1200x1604x740	1 147,-
SRBE-1602 1400x1604x740	1 315,-
SRBE-1603 1600x1604x740	1 333,-
SRBE-1604 1800x1604x740	1 388,-

STELAŻ TYPU: DUO-U DO BIUREK BENCH:
DUO-C, DUO-U, DUO-A, DUO-O, DUO-N
PROFIL: KWADRATOWY 40x40 MM
PROFIL ŁĄCZYNY: 40X20 MM
REGULACJA POZIOMUJĄCA: +/- 10 MM
STAŁA WYSOKOŚĆ: 740 MM

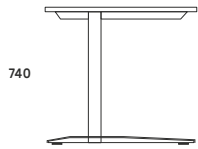

BIURKO PROSTE DUO-L

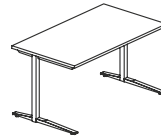
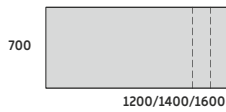

DUO-L 700

LD-P701 1200x700x740	906,-
LD-P702 1400x700x740	950,-
LD-P703 1600x700x740	992,-

BIURKO PROSTE DUO-L

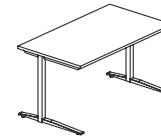
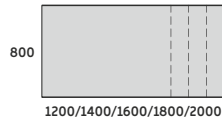

DUO-L 800

LD-P01 1200x800x740	935,-
LD-P02 1400x800x740	979,-
LD-P03 1600x800x740	1 024,-
LD-P04 1800x800x740	1 071,-
LD-P05 2000x800x740	1 078,-

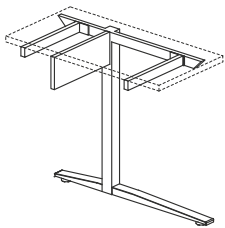

BIURKO PROSTE DUO-L Z JEDNĄ NOGĄ

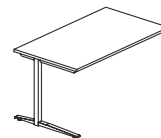
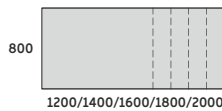

DUO-L 800

LD-P31 P/L 1200x800x740	849,-
LD-P32 P/L 1400x800x740	898,-
LD-P33 P/L 1600x800x740	936,-
LD-P34 P/L 1800x800x740	979,-
LD-P35 P/L 2000x800x740	1 017,-

STELAŻ TYPU: DUO-L
PROFIL: KWADRATOWY 50X50 MM
PROFIL ŁĄCZNY: 40X20 MM
LISTWA WZMACNIAJĄCA GR: 18MM
REGULACJA:
POZIOMUJĄCA W ZAKRESIE: +/- 10 MM

DO KONTENERÓW/SZAFEK GABINETOWYCH:
TP54, TP54/M, TPS3F, TP53F/M, TPSP,
DUSP, ADSP, ODSP, UDSP, CDSP
Z KATALOGU KONTENERY
P/L - KONTENER/SZAFKA PO PRAWEJ/LEWEJ STR.

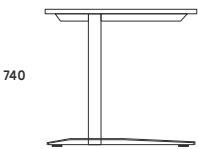

BIURKO NAROŻNE PRAWY DUO-L

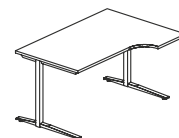
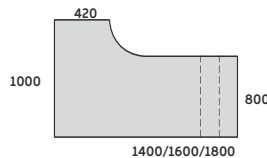

DUO-L NAROŻNE 1000

LD-N11 1400/800x1000/420x740	1 098,-
LD-N14 1600/800x1000/420x740	1 145,-
LD-N16 1800/800x1000/420x740	1 198,-

BIURKO NAROŻNE LEWE DUO-L

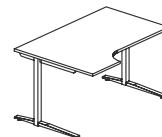
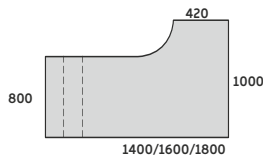

DUO-L NAROŻNE 1000

LD-N12 1400/800x1000/420x740	1 098,-
LD-N15 1600/800x1000/420x740	1 145,-
LD-N17 1800/800x1000/420x740	1 198,-

BIURKO NAROŻNE PRAWY DUO-L

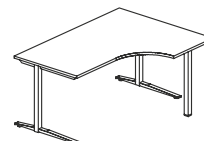
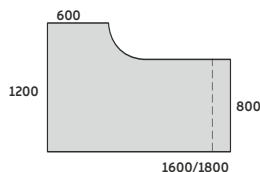

DUO-L NAROŻNE 1200

LD-N21 1600/800x1200/600x740	1 274,-
LD-N23 1800/800x1200/600x740	1 334,-

BIURKO NAROŻNE LEWE DUO-L

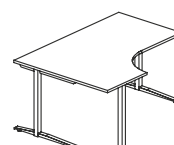
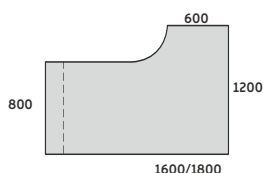

DUO-L NAROŻNE 1200

LD-N22 1600/800x1200/600x740	1 274,-
LD-N24 1800/800x1200/600x740	1 334,-

STELAŻ TYPU: DUO-L
PROFIL: KWADRATOWY 50X50 MM
PROFIL ŁĄCZNY: 40X20 MM
LISTWA WZMACNIAJĄCA GR: 18MM
REGULACJA:
POZIOMUJĄCA W ZAKRESIE: +/- 10 MM

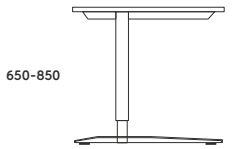

650-850

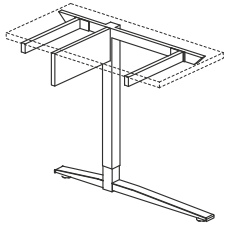

BIURKO PROSTE DUO-L

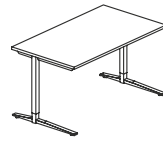
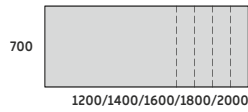

DUO-L 700

LDS-P701 1200x700x650-850	978,-
LDS-P702 1400x700x650-850	1 029,-
LDS-P703 1600x700x650-850	1 064,-
LDS-P704 1800x700x650-850	1 113,-
LDS-P705 2000x700x650-850	1 147,-

BIURKO PROSTE DUO-L

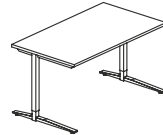
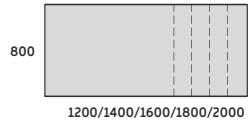

DUO-L 800

LDS-P01 1200x800x650-850	1 009,-
LDS-P02 1400x800x650-850	1 062,-
LDS-P03 1600x800x650-850	1 104,-
LDS-P04 1800x800x650-850	1 152,-
LDS-P05 2000x800x650-850	1 189,-

STELAŻ TYPU: DUO-L SKOKOWY
PROFIL: KWADRATOWY 50X50 MM
PROFIL ŁĄCZYN: 40X20 MM
LISTWA WZMACNIAJĄCA GR: 18MM
REGULACJA:
POZIOMUJĄCA W ZAKRESIE: +/- 10 MM
SKOKOWA W ZAKRESIE: 650-850 MM
CO 20MM

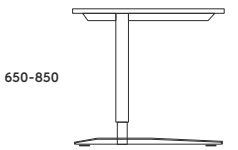

650-850

BIURKO NAROŻNE PRAWO DUO-L

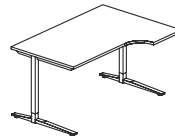
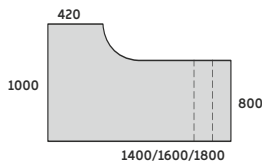

DUO-L NAROŻNE 1000

LDS-N11 1400/800x1000/420x650-850	1 160,-
LDS-N14 1600/800x1000/420x650-850	1 211,-
LDS-N16 1800/800x1000/420x650-850	1 264,-

BIURKO NAROŻNE LEWE DUO-L

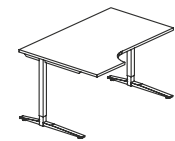
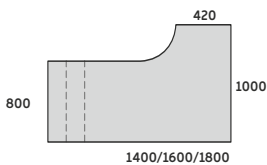

DUO-L NAROŻNE 1000

LDS-N12 1400/800x1000/420x650-850	1 160,-
LDS-N15 1600/800x1000/420x650-850	1 211,-
LDS-N17 1800/800x1000/420x650-850	1 264,-

BIURKO NAROŻNE PRAWO DUO-L

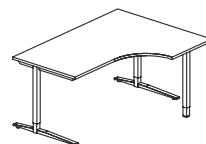
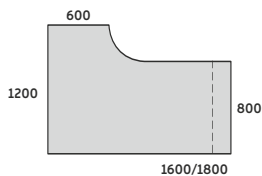

DUO-L NAROŻNE 1200

LDS-N21 1600/800x1200/600x650-850	1 311,-
LDS-N23 1800/800x1200/600x650-850	1 396,-

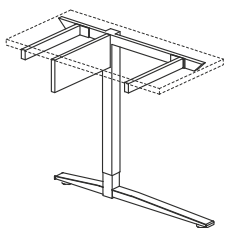

BIURKO NAROŻNE LEWE DUO-L

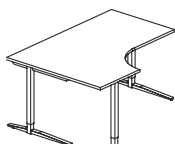
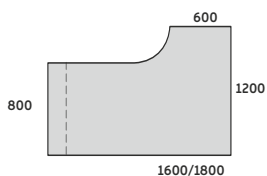

DUO-L NAROŻNE 1200

LDS-N22 1600/800x1200/600x650-850	1 311,-
LDS-N24 1800/800x1200/600x650-850	1 396,-

STELAŻ TYPU: DUO-L SKOKOWY
PROFIL: KWADRATOWY 50X50 MM
PROFIL ŁĄCZYN: 40X20 MM
LISTWA WZMACNIAJĄCA GR: 18MM
REGULACJA:
POZIOMUJĄCA W ZAKRESIE: +/- 10 MM
SKOKOWA W ZAKRESIE: 650-850 MM
CO 20MM

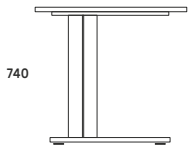

740

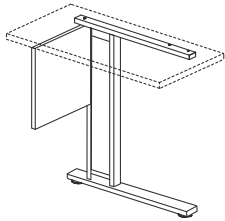

STELAŻ TYPU: DUO-H
PROFIL: PROSTOKĄTNY 50X25 MM
BLENDĄ WZMACNIAJĄCĄ GR: 18MM
PIONOWE PROWADZENIE KABLI W NODZIE
REGULACJA:
POZIOMUJĄCA W ZAKRESIE: +/- 10 MM

BIURKO PROSTE DUO-H

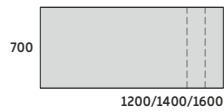

700

1200/1400/1600

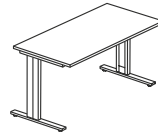

DUO-H 700

HD-P701 1200x700x740	866,-
HD-P702 1400x700x740	897,-
HD-P703 1600x700x740	916,-

BIURKO PROSTE DUO-H

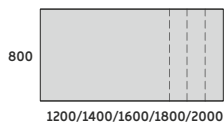

800

1200/1400/1600/1800/2000

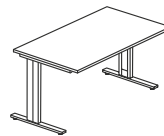

DUO-H 800

HD-P01 1200x800x740	870,-
HD-P02 1400x800x740	900,-
HD-P03 1600x800x740	917,-
HD-P04 1800x800x740	975,-
HD-P05 2000x800x740	991,-

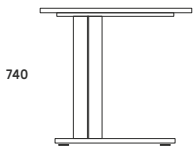

740

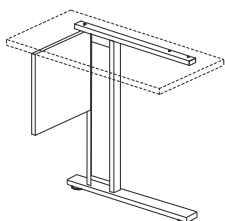

STELAŻ TYPU: DUO-H
PROFIL: PROSTOKĄTNY 50X25 MM
BLENDĄ WZMACNIAJĄCĄ GR: 18MM
REGULACJA:
POZIOMUJĄCA W ZAKRESIE: +/- 10 MM

BIURKO NAROŻNE PRAWY DUO-H

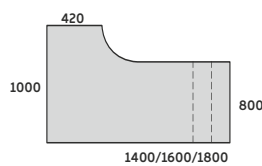

1000

800

1400/1600/1800

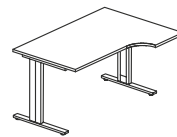

DUO-H NAROŻNE 1000

HD-N11 1400/800x1000/420x740	970,-
HD-N14 1600/800x1000/420x740	1 000,-
HD-N16 1800/800x1000/420x740	1 051,-

BIURKO NAROŻNE LEWE DUO-H

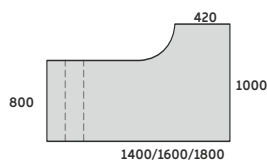

800

1000

1400/1600/1800

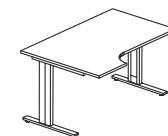

DUO-H NAROŻNE 1000

HD-N12 1400/800x1000/420x740	970,-
HD-N15 1600/800x1000/420x740	1 000,-
HD-N17 1800/800x1000/420x740	1 051,-

BIURKO NAROŻNE PRAWY DUO-H

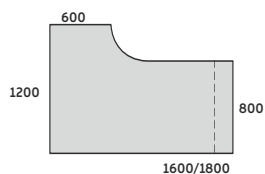

1200

800

1600/1800

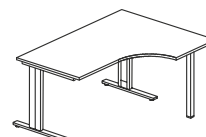

DUO-H NAROŻNE 1200

HD-N21 1600/800x1200/600x740	1 261,-
HD-N23 1800/800x1200/600x740	1 287,-

BIURKO NAROŻNE LEWE DUO-H

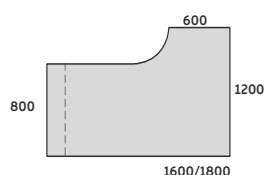

800

1200

1600/1800

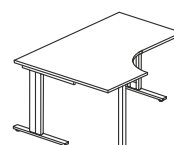

DUO-H NAROŻNE 1200

HD-N22 1600/800x1200/600x740	1 261,-
HD-N24 1800/800x1200/600x740	1 287,-

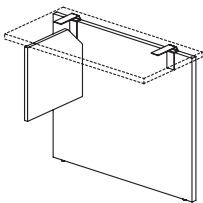
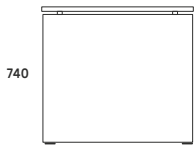

STELAŻ TYPU: DUO-P
KONSTRUKCJA PŁYTOWA: GR.25 MM
BLENDY KONSTRUKCYJNA: 18 MM
REGULACJA:
POZIOMUJĄCA W ZAKRESIE: +/- 10 MM

BIURKO PROSTE DUO-P

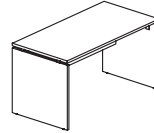
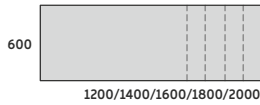

DUO-P 600

PD-P601 1200x600x740	585,-
PD-P602 1400x600x740	617,-
PD-P603 1600x600x740	650,-
PD-P604 1800x600x740	681,-
PD-P605 2000x600x740	708,-

BIURKO PROSTE DUO-P

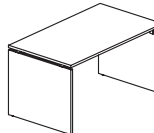
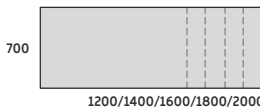

DUO-P 700

PD-P701 1200x700x740	597,-
PD-P702 1400x700x740	630,-
PD-P703 1600x700x740	663,-
PD-P704 1800x700x740	695,-
PD-P705 2000x700x740	722,-

BIURKO PROSTE DUO-P

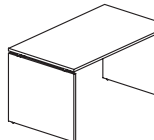
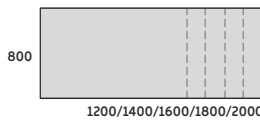

DUO-P 800

PD-P01 1200x800x740	636,-
PD-P02 1400x800x740	674,-
PD-P03 1600x800x740	725,-
PD-P04 1800x800x740	760,-
PD-P05 2000x800x740	804,-

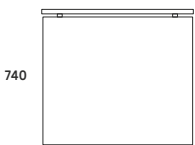

STELAŻ TYPU: DUO-P
KONSTRUKCJA PŁYTOWA: GR.25 MM
BLENDY KONSTRUKCYJNA: 18 MM
REGULACJA:
POZIOMUJĄCA W ZAKRESIE: +/- 10 MM

BIURKO NAROŻNE PRAWY DUO-P

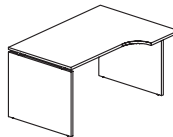
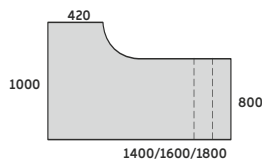

DUO-P NAROŻNE 1000

PD-N11 1400/800x1000/420x740	813,-
PD-N14 1600/800x1000/420x740	866,-
PD-N16 1800/800x1000/420x740	908,-

BIURKO NAROŻNE LEWE DUO-P

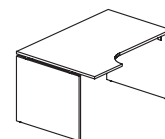
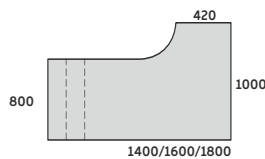

DUO-P NAROŻNE 1000

PD-N12 1400/800x1000/420x740	813,-
PD-N15 1600/800x1000/420x740	866,-
PD-N17 1800/800x1000/420x740	908,-

BIURKO NAROŻNE PRAWY DUO-P

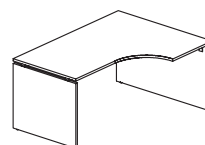
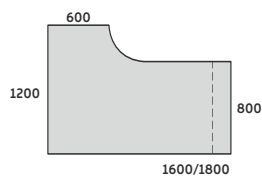

DUO-P NAROŻNE 1200

PD-N21 1600/800x1200/600x740	1 001,-
PD-N23 1800/800x1200/600x740	1 051,-

BIURKO NAROŻNE LEWE DUO-P

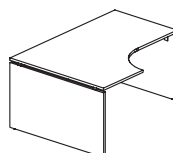
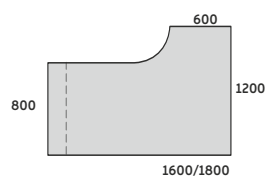

DUO-P NAROŻNE 1200

PD-N22 1600/800x1200/600x740	1 001,-
PD-N24 1800/800x1200/600x740	1 051,-

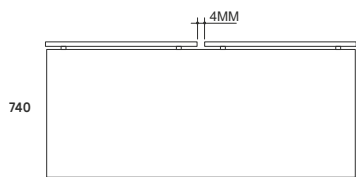

BENCH DUO-P

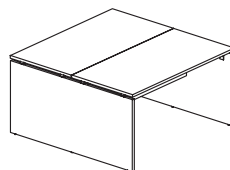
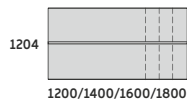

DUO-P 1204

PD-BE1201 1200x1204x740	1 134,-
PD-BE1202 1400x1204x740	1 254,-
PD-BE1203 1600x1204x740	1 279,-
PD-BE1204 1800x1204x740	1 298,-

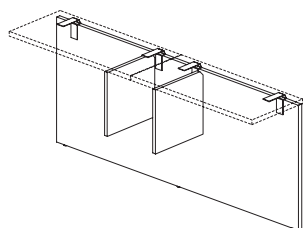

BENCH DUO-P

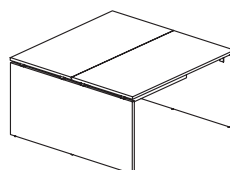
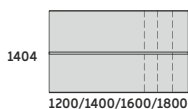

DUO-P 1404

PD-BE1401 1200x1404x740	1 157,-
PD-BE1402 1400x1404x740	1 280,-
PD-BE1403 1600x1404x740	1 305,-
PD-BE1404 1800x1404x740	1 325,-

STELAŻ TYPU: DUO-P
KONSTRUKCJA PŁYTOWA: GR.25 MM
BLENDY KONSTRUKCYJNA: 18 MM
REGULACJA:
POZIOMUJĄCA W ZAKRESIE: +/- 10 MM

BENCH DUO-P

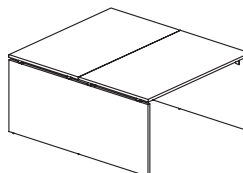
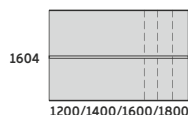

DUO-P 1604

PD-BE1601 1200x1604x740	1 230,-
PD-BE1602 1400x1604x740	1 346,-
PD-BE1603 1600x1604x740	1 370,-
PD-BE1604 1800x1604x740	1 396,-

MODUŁ ŚRODKOWY

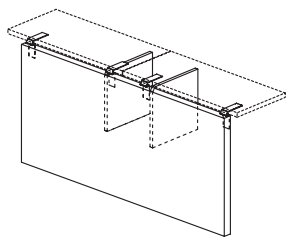

MODUŁ ŚRODKOWY

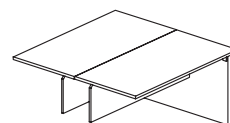
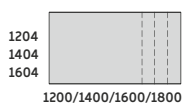

DUO-P 1204

SRPD-1201 1200x1204x740	965,-
SRPD-1202 1400x1204x740	1 093,-
SRPD-1203 1600x1204x740	1 120,-
SRPD-1204 1800x1204x740	1 139,-

DUO-P 1404

SRPD-1401 1200x1404x740	985,-
SRPD-1402 1400x1404x740	1 115,-
SRPD-1403 1600x1404x740	1 142,-
SRPD-1404 1800x1404x740	1 162,-

DUO-P 1604

SRPD-1601 1200x1604x740	1 230,-
SRPD-1602 1400x1604x740	1 346,-
SRPD-1603 1600x1604x740	1 370,-
SRPD-1604 1800x1604x740	1 396,-

STELAŻ TYPU: DUO-P
DO BIUREK BENCH: DUO-P
KONSTRUKCJA PŁYTOWA: GR.25 MM
BLENDY KONSTRUKCYJNA: 18 MM
REGULACJA:
POZIOMUJĄCA W ZAKRESIE: +/- 10 MM

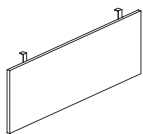

PANEL PŁYTOWY

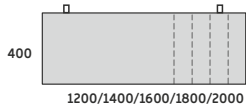

PANEL METALOWY PERFOROWANY

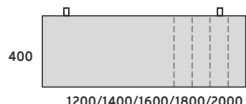
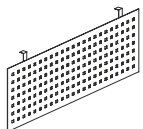

PANEL PŁYTOWY

DBLP-01 1200x20x400	176,-
DBLP-02 1400x20x400	187,-
DBLP-03 1600x20x400	200,-
DBLP-04 1800x20x400	212,-
DBLP-05 2000x20x400	223,-

PANEL METALOWY

DBLM-01 1200x20x400	448,-
DBLM-02 1400x20x400	511,-
DBLM-03 1600x20x400	577,-
DBLM-04 1800x20x400	635,-
DBLM-05 2000x20x400	688,-

PRZELOTKI KABLOWE

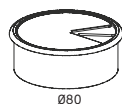

Ø80

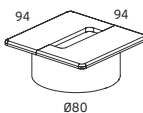

Ø80

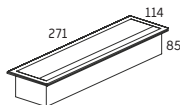

PRZELOTKA OKRĄGŁA

PR Ø80 21,-

PRZELOTKA KWADRAT

KWP 94x94 Ø80 38,-

PRZELOTKA PROSTOKĄTNA

PK 271x114x85 279,-

ORGANIZACJA KABLI



KRĘGOSŁUP NA KABELE

KR Wysokość 700 176,-



OSŁONA KABLI

OKM 520x50x53 211,-

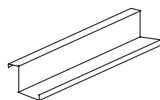

KORYTO NA KABELE

KM-01 Długość: 400 115,-



POZIOME PROWADZENIE KABLI

GR 1000x68x35 88,-

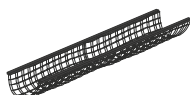

SIATKA NA KABELE

KS-01 1000x350x80 89,-

TYLKO DLA STELAŻY

DUO-U
DUO-A
DUO-O
DUO-L

ZALECA SIĘ ZASTOSOWANIE:

2 SZT. DO BIURKA 1200 MM
2 SZT. DO BIURKA 1400 MM
3 SZT. DO BIURKA 1600 MM
3 SZT. DO BIURKA 1800 MM
4 SZT. DO BIURKA 2000 MM

ELEMENTY PC

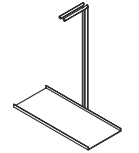
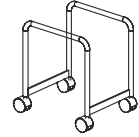
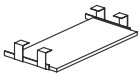

PÓŁKA NA KLAWIATURĘ

KL-002 650x300x90 204,-

WÓZEK NA PC

WK-02 255x300x350 270,-

WIESZAK NA PC

ZK 500x224x515 350,-

PRZEGRODY DUO

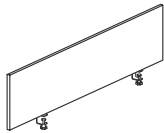

PRZEGRODY PŁYTOWE NASTAWIANE DO BIUREK BENCH LUB POJEDYNCZYCH



350

DO BIUREK
1200/1400/1600/1800/2000

PRZEGRODY PŁYTOWE

DBPP-01 1200x18x350 218,-
DBPP-02 1400x18x350 231,-
DBPP-03 1600x18x350 241,-
DBPP-04 1800x18x350 251,-
DBPP-05 2000x18x350 262,-

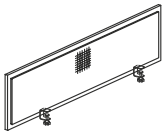

PRZEGRODY TAPICEROWANE DWUSTRONNIE NASTAWIANE DO BIUREK BENCH LUB POJEDYNCZYCH



350

DO BIUREK
1200/1400/1600/1800/2000

PRZEGRODY TAPICEROWANE

DBPD-01 1200x18x350 522,-
DBPD-02 1400x18x350 557,-
DBPD-03 1600x18x350 593,-
DBPD-04 1800x18x350 630,-
DBPD-05 2000x18x350 668,-

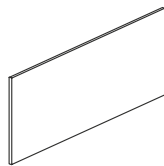

PRZEGRODY PŁYTOWE DO BIUREK POJEDYNCZYCH Z PRZEWIESZENIEM



550

DO BIUREK
1200/1400/1600/1800/2000

PRZEGRODY PŁYTOWE

DPP-01 1200x18x550 351,-
DPP-02 1400x18x550 366,-
DPP-03 1600x18x550 381,-
DPP-04 1800x18x550 396,-
DPP-05 2000x18x550 412,-

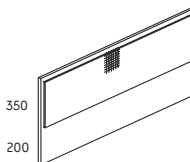

PRZEGRODY TAPICEROWANE JEDNOSTRONNIE DO BIUREK POJEDYNCZYCH Z PRZEWIESZENIEM



550

DO BIUREK:
1200/1400/1600/1800/2000

PRZEGRODY TAPICEROWANE

DPI-01 1200x18x550 502,-
DPI-02 1400x18x550 530,-
DPI-03 1600x18x550 558,-
DPI-04 1800x18x550 597,-
DPI-05 2000x18x550 635,-

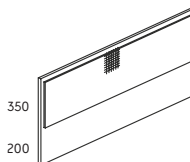

PRZEGRODY TAPICEROWANE DWUSTRONNIE DO BIUREK POJEDYNCZYCH Z PRZEWIESZENIEM



550

DO BIUREK:
1200/1400/1600/1800/2000

PRZEGRODY TAPICEROWANE

DPD-01 1200x18x550 642,-
DPD-02 1400x18x550 681,-
DPD-03 1600x18x550 722,-
DPD-04 1800x18x550 764,-
DPD-05 2000x18x550 806,-

OPIS:

- WYKOŃCZENIE BIAŁĄ LUB CZARNĄ TAŚMĄ
Z TWORZYWA SZTUCZNEGO

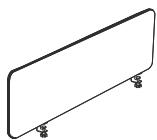

PRZEGRODY TAPICEROWANE DWUSTRONNIE DO BIUREK Z MOCOWANIEM ZP

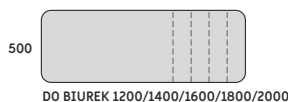

PRZEGRODY TAPICEROWANE

P50-01/ZP 1200x40x500	540,-
P50-02/ZP 1400x40x500	568,-
P50-03/ZP 1600x40x500	596,-
P50-04/ZP 1800x40x500	624,-
P50-05/ZP 2000x40x500	653,-

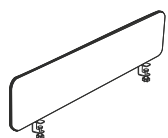

PRZEGRODY TAPICEROWANE DWUSTRONNIE DO BIUREK Z MOCOWANIEM ZP

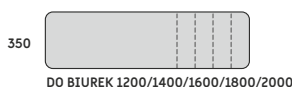

PRZEGRODY TAPICEROWANE

P35-01/ZP 1200x40x350	483,-
P35-02/ZP 1400x40x350	498,-
P35-03/ZP 1600x40x350	515,-
P35-04/ZP 1800x40x350	541,-
P35-05/ZP 2000x40x350	568,-

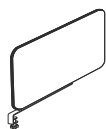

PRZEGRODY TAPICEROWANE DWUSTRONNIE BOCZNA Z MOCOWANIEM ZB



PRZEGRODY TAPICEROWANE

PB50/700/ZB 700x40x500	350,-
PB50/800/ZB 800x40x500	377,-

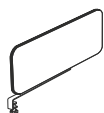

PRZEGRODY TAPICEROWANE DWUSTRONNIE BOCZNA Z MOCOWANIEM ZB



PRZEGRODY TAPICEROWANE

PB35/700/ZB 700x40x500	316,-
PB35/800/ZB 800x40x500	332,-

PRZEGRODY PASUJĄ DO BIUREK:

POJEDYNCZYCH DUO
POJEDYNCZYCH InUP (PRZEGRODA ZMIENIA POŁOŻENIE RAZEM Z BLATEM)
DUO BENCH

PRZEGRODY NIE PASUJĄ DO BIUREK:

InUP BENCH

CENA DOTYCZY TYLKO TKANINY EVO I NEXT

DOSTAWKI DO BIUREK BEZ ŁĄCZINY

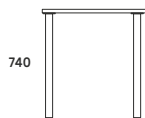

STELAŻ TYPU: DUO-U
PROFIL: KWADRATOWY 50X50 MM
REGULACJA:
POZIOMUJĄCA W ZAKRESIE: +/- 10 MM

DOSTAWKA DO BIURKA DUO-U MONTOWANA Z PRZODU LUB Z BOKU

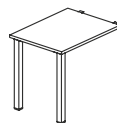
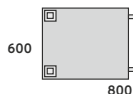

DOSTAWKA DO BIURKA DUO-U
KD-01 800x600x740 478,-

DOSTAWKA DO BIURKA DUO-U MONTOWANA Z PRZODU LUB Z BOKU

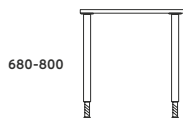

STELAŻ TYPU: DUO-U
PROFIL: KWADRATOWY 50X50 MM
REGULACJA:
PŁYNNA W ZAKRESIE: 680÷800 MM

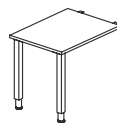
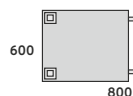

DOSTAWKA DO BIURKA DUO-U
KDP-01 800x600x680-800 517,-

DOSTAWKA DO BIURKA DUO-U MONTOWANA Z PRZODU LUB Z BOKU

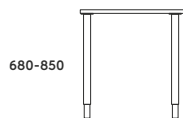

STELAŻ TYPU: DUO-U
PROFIL: KWADRATOWY 50X50 MM
REGULACJA:
SKOKOWA W ZAKRESIE: 650÷850 MM
CO 20MM

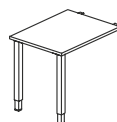
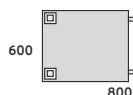

DOSTAWKA DO BIURKA DUO-U
KDS-01 800x600x650-850 576,-

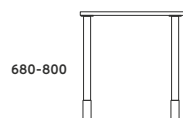

STELAŻ TYPU: DUO-C
PROFIL PIONU: OKRĄGŁY Ø40 MM
REGULACJA:
PŁYNNA W ZAKRESIE: 680÷800 MM

DOSTAWKA DO BIURKA DUO-C MONTOWANA Z PRZODU LUB Z BOKU

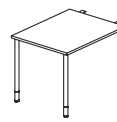
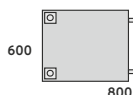

DOSTAWKA DO BIURKA DUO-C
OD-01 800x600x680-800 440,-

DOSTAWKI DO BIUREK Z ŁĄCZYNĄ

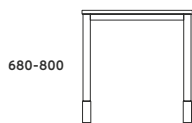

680-800

STELAŻ TYPU: DUO-C
PROFIL PIONU: OKRĄGŁY Ø40 MM
PROFIL ŁĄCZYNY: 40X20 MM
REGULACJA:
PŁYNNA W ZAKRESIE: 680÷800 MM

DOSTAWKA DO BIURKA DUO-C MONTOWANA Z PRZODU

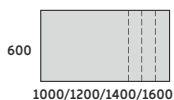

600

1000/1200/1400/1600

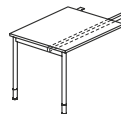

DOSTAWKA DO BIURKA DUO-C

CDDP-01	1000x600x680-800	545,-
CDDP-02	1200x600x680-800	558,-
CDDP-03	1400x600x680-800	572,-
CDDP-04	1600x600x680-800	686,-

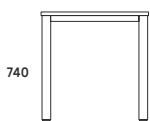

740

STELAŻ TYPU: DUO-U
PROFIL: KWADRATOWY 50X50 MM
PROFIL ŁĄCZYNY: 40X20 MM
REGULACJA:
POZIOMUJĄCA W ZAKRESIE: +/- 10 MM

DOSTAWKA DO BIURKA DUO-U MONTOWANA Z PRZODU

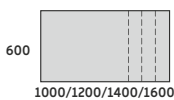

600

1000/1200/1400/1600

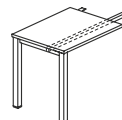

DOSTAWKA DO BIURKA DUO-U

UDD-01	1000x600x740	568,-
UDD-02	1200x600x740	579,-
UDD-03	1400x600x740	590,-
UDD-04	1600x600x740	602,-

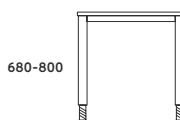

680-800

STELAŻ TYPU: DUO-U
PROFIL: KWADRATOWY 50X50 MM
PROFIL ŁĄCZYNY: 40X20 MM
REGULACJA:
PŁYNNA W ZAKRESIE: 680÷800 MM

DOSTAWKA DO BIURKA DUO-U MONTOWANA Z PRZODU

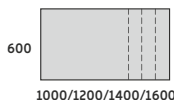

600

1000/1200/1400/1600

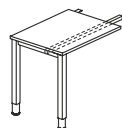

DOSTAWKA DO BIURKA DUO-U

UDDP-01	1000x600x680-800	575,-
UDDP-02	1200x600x680-800	586,-
UDDP-03	1400x600x680-800	598,-
UDDP-04	1600x600x680-800	610,-

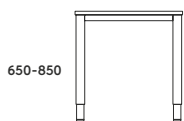

650-850

STELAŻ TYPU: DUO-U
PROFIL: KWADRATOWY 50X50 MM
PROFIL ŁĄCZYNY: 40X20 MM
REGULACJA:
POZIOMUJĄCA W ZAKRESIE: +/- 10 MM
SKOKOWA W ZAKRESIE: 650÷850 MM
CO 20MM

DOSTAWKA DO BIURKA DUO-U MONTOWANA Z PRZODU

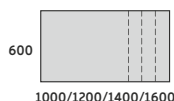

600

1000/1200/1400/1600

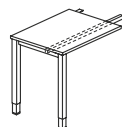

DOSTAWKA DO BIURKA DUO-U

UDDS-01	1000x600x650-850	615,-
UDDS-02	1200x600x650-850	628,-
UDDS-03	1400x600x650-850	640,-
UDDS-04	1600x600x650-850	653,-

DOSTAWKI DO BIUREK Z ŁĄCZYNĄ



STELAŻ TYPU: DUO-A
PROFIL: PROSTOKĄTNY 50X25 MM
PROFIL ŁĄCZYNY: 40X20 MM
REGULACJA:
POZIOMUJĄCA W ZAKRESIE: +/- 10 MM



STELAŻ TYPU: DUO-A
PROFIL: PROSTOKĄTNY 50X25 MM
PROFIL ŁĄCZYNY: 40X20 MM
REGULACJA:
POZIOMUJĄCA W ZAKRESIE: +/- 10 MM
SKOKOWA W ZAKRESIE: 650÷850 MM
CO 20 MM

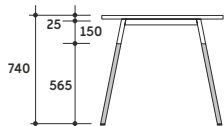

STELAŻ TYPU: DUO-A
PROFIL: PROSTOKĄTNY 50X25 MM
PROFIL ŁĄCZYNY: 40X20 MM
REGULACJA:
POZIOMUJĄCA W ZAKRESIE: +/- 10 MM

KOLORYSTYKA DREWNA:



DOSTAWKA DO BIURKA DUO-A MONTOWANA Z PRZODU

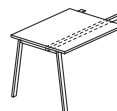
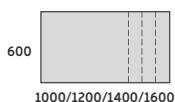

DOSTAWKA DO BIURKA DUO-A

ADD-01 1000x600x740	574,-
ADD-02 1200x600x740	588,-
ADD-03 1400x600x740	603,-
ADD-04 1600x600x740	612,-

DOSTAWKA DO BIURKA DUO-A MONTOWANA Z PRZODU

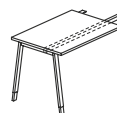
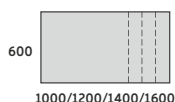

DOSTAWKA DO BIURKA DUO-A

ADDS-01 1000x600x650-850	615,-
ADDS-02 1200x600x650-850	627,-
ADDS-03 1400x600x650-850	640,-
ADDS-04 1600x600x650-850	653,-

DOSTAWKA DO BIURKA DUO-A WOOD MONTOWANA Z PRZODU

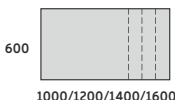

DOSTAWKA DO BIURKA DUO-A WOOD

ADD-01/D 1000x600x740	764,-
ADD-02/D 1200x600x740	778,-
ADD-03/D 1400x600x740	793,-
ADD-04/D 1600x600x740	802,-

DOSTAWKI DO BIUREK Z ŁĄCZYŃĄ

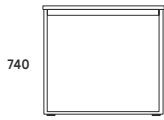

STELAŻ TYPU: DUO-O
PROFIL: PROSTOKĄTNY 50X25 MM
PROFIL ŁĄCZYŃNY: 40X20 MM
REGULACJA:
POZIOMUJĄCA W ZAKRESIE: +/- 10 MM

DOSTAWKA DO BIURKA DUO-O MONTOWANA Z PRZODU

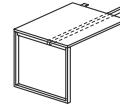
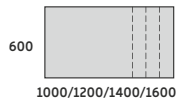

DOSTAWKA DO BIURKA DUO-O

ODD-01 1000x600x740	578,-
ODD-02 1200x600x740	591,-
ODD-03 1400x600x740	602,-
ODD-04 1600x600x740	614,-

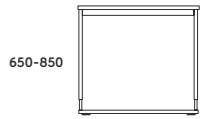

STELAŻ TYPU: DUO-O
PROFIL: PROSTOKĄTNY 50X25 MM
PROFIL ŁĄCZYŃNY: 40X20 MM
REGULACJA:
POZIOMUJĄCA W ZAKRESIE: +/- 10 MM
SKOKOWA W ZAKRESIE: 650÷850 MM
CO 20MM

DOSTAWKA DO BIURKA DUO-O MONTOWANA Z PRZODU

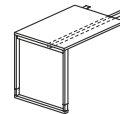
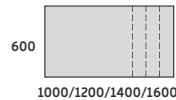

DOSTAWKA DO BIURKA DUO-O

ODDS-01 1000x600x650-850	630,-
ODDS-02 1200x600x650-850	643,-
ODDS-03 1400x600x650-850	655,-
ODDS-04 1600x600x650-850	688,-

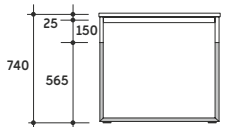

STELAŻ TYPU: DUO-O
PROFIL: PROSTOKĄTNY 50X25 MM
PROFIL ŁĄCZYŃNY: 40X20 MM
REGULACJA:
POZIOMUJĄCA W ZAKRESIE: +/- 10 MM

DOSTAWKA DO BIURKA DUO-O WOOD MONTOWANA Z PRZODU

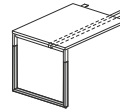
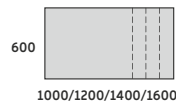

DOSTAWKA DO BIURKA DUO-O WOOD

ODD-01/D 1000x600x740	824,-
ODD-02/D 1200x600x740	837,-
ODD-03/D 1400x600x740	848,-
ODD-04/D 1600x600x740	860,-

KOLORYSTYKA DREWNA:

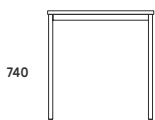

STELAŻ TYPU: DUO-N
PROFIL: PROSTOKĄTNY 50X25 MM
PROFIL ŁĄCZYŃNY: 40X20 MM
REGULACJA:
POZIOMUJĄCA W ZAKRESIE: +/- 10 MM

DOSTAWKA DO BIURKA DUO-N MONTOWANA Z PRZODU

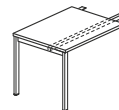
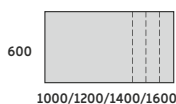

DOSTAWKA DO BIURKA DUO-N

NDD-01 1000x600x740	562,-
NDD-02 1200x600x740	572,-
NDD-03 1400x600x740	584,-
NDD-04 1600x600x740	604,-

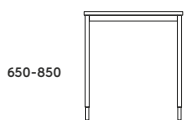

STELAŻ TYPU: DUO-N
PROFIL: KWADRATOWY 50X25 MM
PROFIL ŁĄCZYŃNY: 40X20 MM
REGULACJA:
SKOKOWA W ZAKRESIE: 650÷850 MM
CO 20MM

DOSTAWKA DO BIURKA DUO-N MONTOWANA Z PRZODU

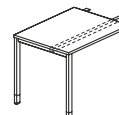

DOSTAWKA DO BIURKA DUO-N

NDDS-01 1000x600x680-800	590,-
NDDS-02 1200x600x680-800	600,-
NDDS-03 1400x600x680-800	616,-
NDDS-04 1600x600x680-800	640,-

OPIS:

- TOP 18MM
- DÓŁ 18MM
- KORPUS 18MM
- FRONTY SZUFLAD 18MM
- ZAMEK CENTRALNY

SZAFKI I KONTENERY PRZYBIURKOWE

PŁYTOWE

METALOWE

KONTENERY POD BIURKO Z JEDNĄ NOGĄ

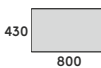

**KONTENER POD BIURKO
Z JEDNĄ NOGĄ**
-1 WKŁAD PIÓRNIKOWY
-4 SZUFLADY PŁYTOWE

TPS4 430x800x625 921,-

**KONTENER POD BIURKO
Z JEDNĄ NOGĄ**
-1 WKŁAD PIÓRNIKOWY
-4 SZUFLADY METALOWE

TPS4/M 430x800x625 1 645,-

KONTENERY POD BIURKO Z JEDNĄ NOGĄ



**KONTENER POD BIURKO
Z JEDNĄ NOGĄ**
-1 WKŁAD PIÓRNIKOWY
-2 SZUFLADY PŁYTOWE
-1 SZUFLADA PŁYTOWA
NA TECZKI ZAWIESZKOWE

TPS3F 430x800x625 927,-

**KONTENER POD BIURKO
Z JEDNĄ NOGĄ**
-WKŁAD PIÓRNIKOWY
-2 SZUFLADY METALOWE
-1 SZUFLADA METALOWA
NA TECZKI ZAWIESZKOWE

TPS3F/M 430x800x625 1 570,-

SZAFKA POD BIURKO Z JEDNĄ NOGĄ

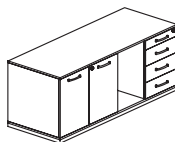
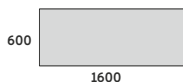

SZAFKA POD BIURKO Z JEDNĄ NOGĄ

-1 WKŁAD PIÓRNIKOWY
-4 SZUFLADY PŁYTOWE
-2 DRZWI CZYNI Z ZAMKIEM
UCHWYT DO WYBORU UB, US, UC

DUSP P/L 1600x600x625 1 995,-

SZAFKA POD BIURKO Z JEDNĄ NOGĄ

-1 WKŁAD PIÓRNIKOWY
-4 SZUFLADY METALOWE
-2 DRZWI CZYNI Z ZAMKIEM
UCHWYT DO WYBORU UB, US, UC

DUSP/M P/L 1600x600x625 2 503,-

SZAFKA POD BIURKO Z JEDNĄ NOGĄ

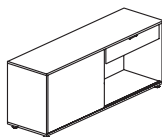

SZAFKA POD BIURKO Z JEDNĄ NOGĄ

-WKŁAD JEDNOSZUFLADOWY
Z SZUFLADĄ PŁYTOWĄ
PO PRAWĘJ / LEWEJ STRONIE
-DRZWI PRZESUWANE

TPSP 1600x450x625 1 503,-

SZAFKA POD BIURKO Z JEDNĄ NOGĄ

-WKŁAD JEDNOSZUFLADOWY
Z SZUFLADĄ METALOWĄ
PO PRAWĘJ / LEWEJ STRONIE
-DRZWI PRZESUWANE

TPSP/M 1600x450x625 1 769,-

SZAFKA POD BIURKO Z JEDNĄ NOGĄ

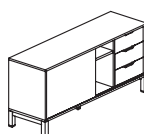
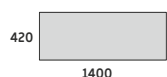

SZAFKA POD BIURKO Z JEDNĄ NOGĄ

-3 SZUFLADY PŁYTOWE
-DRZWI PRZESUWANE
-P/L SZUFLADY PO PRAWĘJ / LEWEJ STRONIE
-SZAFKA NA STELAŻU SIM-U

UDSP P/L 1400x420x625 1 648,-

SZAFKA POD BIURKO Z JEDNĄ NOGĄ

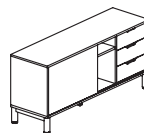

SZAFKA POD BIURKO Z JEDNĄ NOGĄ

-3 SZUFLADY PŁYTOWE
-DRZWI PRZESUWANE
-P/L SZUFLADY PO PRAWĘJ / LEWEJ STRONIE
-SZAFKA NA STELAŻU SIM-C

CDSP P/L 1400x420x625 1 688,-

SZAFKA POD BIURKO Z JEDNĄ NOGĄ

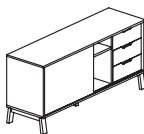

SZAFKA POD BIURKO Z JEDNĄ NOGĄ

-3 SZUFLADY PŁYTOWE
-DRZWI PRZESUWANE
-P/L SZUFLADY PO PRAWĘJ / LEWEJ STRONIE
-SZAFKA NA STELAŻU SIM-A

ADSP P/L 1400x420x625 1 698,-

SZAFKA POD BIURKO Z JEDNĄ NOGĄ

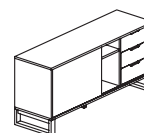

SZAFKA POD BIURKO Z JEDNĄ NOGĄ

-3 SZUFLADY PŁYTOWE
-DRZWI PRZESUWANE
-P/L SZUFLADY PO PRAWĘJ / LEWEJ STRONIE
-SZAFKA NA STELAŻU SIM-O

ODSP P/L 1400x420x625 1 683,-

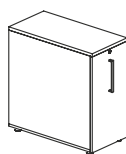
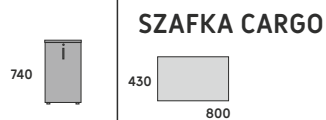

SZAFKA CARGO
 -1 PRZESTRZEŃ NA SEGREGATOR
 -1 PRZESTRZEŃ WOLNA
 -FRONT 18MM
 -UCHWYT DO WYBORU UD, UB, UC

TCN-P 430x800x740 1 790,-
 TCN-L 430x800x740 1 790,-

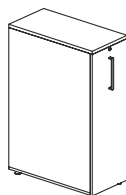
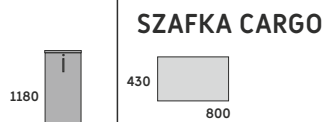

SZAFKA CARGO
 -2 PRZESTRZENIE NA SEGREGATOR
 -1 PRZESTRZEŃ WOLNA
 -FRONT 18MM
 -UCHWYT DO WYBORU UD, UB, UC

TCW-P 430x800x1180 2 050,-
 TCW-L 430x800x1180 2 050,-

STOŁY KONFERENCYJNE Z PRZEWIESZENIEM

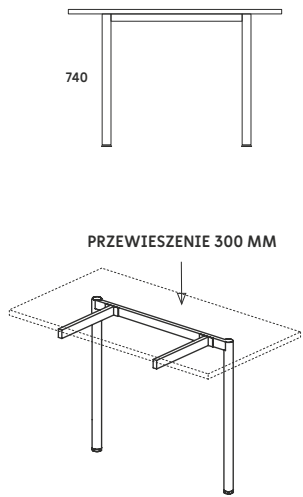

STELAŻ TYPU: DUO-C
PROFIL PIONU: OKRĄGŁY Ø40 MM
PROFIL ŁĄCZNY: 60X20 MM
REGULACJA POZIOMUJĄCA: +/- 10 MM

STÓŁ KONFERENCYJNY DUO-C

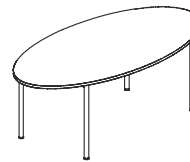
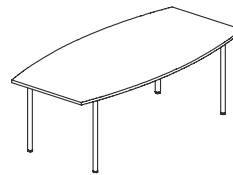
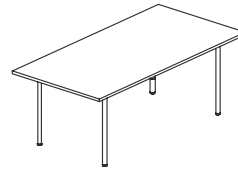
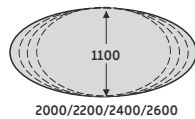
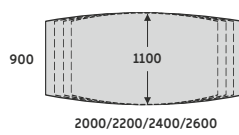
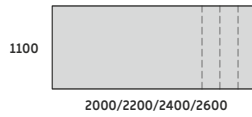

DUO-C

CD-SKP01 2000x1100x740	1 340,-
CD-SKP02 2200x1100x740	1 400,-
CD-SKP03 2400x1100x740	1 472,-
CD-SKP04 2600x1100x740	1 530,-

DUO-C

CD-SKB01 2000x900/1100x740	1 500,-
CD-SKB02 2200x900/1100x740	1 570,-
CD-SKB03 2400x900/1100x740	1 640,-
CD-SKB04 2600x900/1100x740	1 711,-

DUO-C

CD-SKE01 2000x1100x740	1 500,-
CD-SKE02 2200x1100x740	1 570,-
CD-SKE03 2400x1100x740	1 595,-
CD-SKE04 2600x1100x740	1 640,-

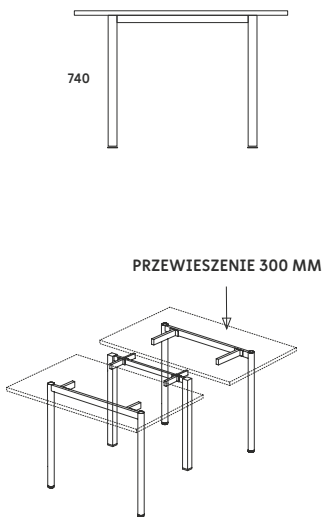

STELAŻ TYPU: DUO-C
PROFIL PIONU: OKRĄGŁY Ø40 MM
PROFIL ŁĄCZNY: 60X20 MM
PROFIL NOGI ŚRODKOWEJ: 40X40 MM
REGULACJA POZIOMUJĄCA: +/- 10 MM

STÓŁ KONFERENCYJNY DUO-C

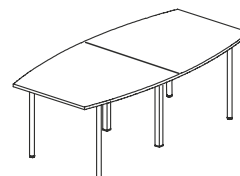
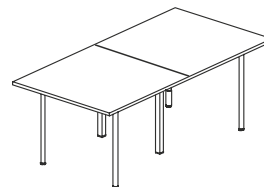
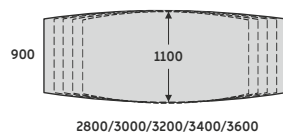
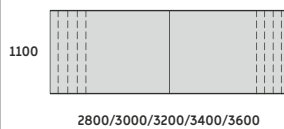

DUO-C

CD-SKP05 2800x1100x740	1 750,-
CD-SKP06 3000x1100x740	1 830,-
CD-SKP07 3200x1100x740	1 917,-
CD-SKP08 3400x1100x740	2 012,-
CD-SKP09 3600x1100x740	2 093,-

DUO-C

CD-SKB05 2800x900/1100x740	1 830,-
CD-SKB06 3000x900/1100x740	1 910,-
CD-SKB07 3200x900/1100x740	2 000,-
CD-SKP08 3400x900/1100x740	2 100,-
CD-SKP09 3600x900/1100x740	2 198,-

MODUŁ ROZSZERZAJĄCY

SR-P01 1000x1100x740	1 235,-
SR-P02 1200x1100x740	1 258,-
SR-P03 1400x1100x740	1 310,-
SR-P04 1600x1100x740	1 380,-

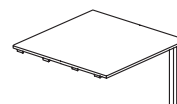

STÓŁY KONFERENCYJNE Z PRZEWIESZENIEM

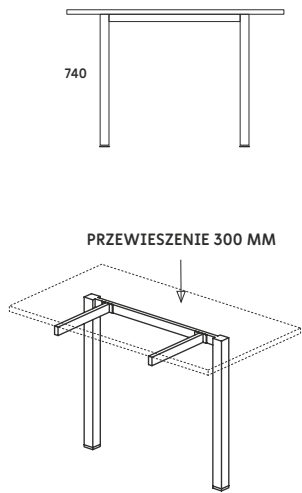

STELAŻ TYPU: DUO-U
PROFIL: KWADRATOWY 50X50 MM
PROFIL ŁĄCZYNY: 60X20 MM
REGULACJA POZIOMUJĄCA: +/- 10 MM

STÓŁ KONFERENCYJNY DUO-U

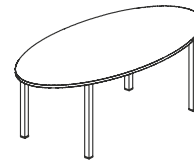
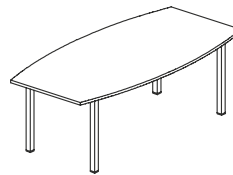
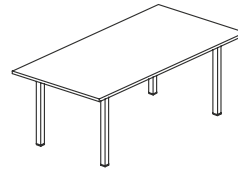
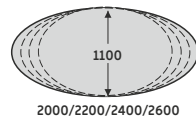
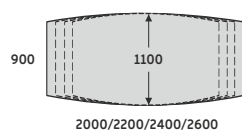
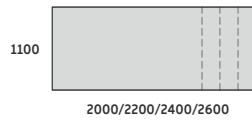

DUO-U

UD-SKP01 2000x1100x740	1 450,-
UD-SKP02 2200x1100x740	1 517,-
UD-SKP03 2400x1100x740	1 593,-
UD-SKP04 2600x1100x740	1 670,-

DUO-U

UD-SKB01 2000x900/1100x740	1 640,-
UD-SKB02 2200x900/1100x740	1 722,-
UD-SKB03 2400x900/1100x740	1 810,-
UD-SKB04 2600x900/1100x740	1 880,-

DUO-U

UD-SKE01 2000x1100x740	1 590,-
UD-SKE02 2200x1100x740	1 670,-
UD-SKE03 2400x1100x740	1 750,-
UD-SKE04 2600x1100x740	1 802,-

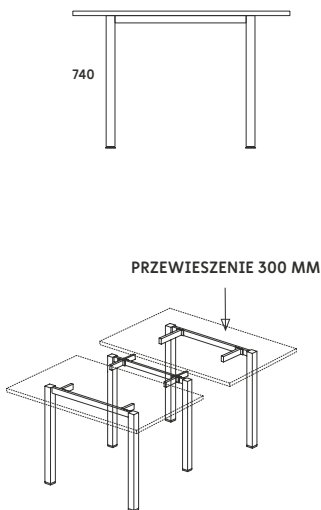

STELAŻ TYPU: DUO-U
PROFIL: KWADRATOWY 50X50 MM
PROFIL ŁĄCZYNY: 60X20 MM
PROFIL NOGI ŚRODKOWEJ: 40X40 MM
REGULACJA POZIOMUJĄCA: +/- 10 MM

STÓŁ KONFERENCYJNY DUO-U

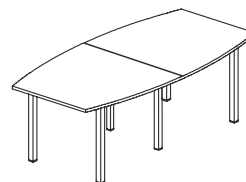
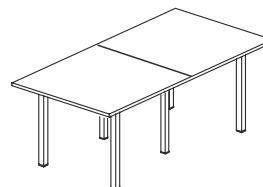
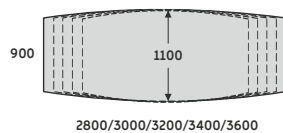
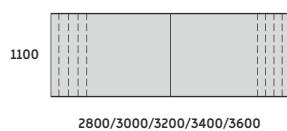

DUO-U

UD-SKP05 2800x1100x740	1 785,-
UD-SKP06 3000x1100x740	1 874,-
UD-SKP07 3200x1100x740	1 968,-
UD-SKP08 3400x1100x740	2 066,-
UD-SKP09 3600x1100x740	2 170,-

DUO-U

UD-SKB05 2800x900/1100x740	1 874,-
UD-SKB06 3000x900/1100x740	1 968,-
UD-SKB07 3200x900/1100x740	2 066,-
UD-SKB08 3400x900/1100x740	2 169,-
UD-SKB09 3600x900/1100x740	2 277,-

MODUŁ ROZSZERZAJĄCY

SR-P01 1000x1100x740	1 235,-
SR-P02 1200x1100x740	1 258,-
SR-P03 1400x1100x740	1 310,-
SR-P04 1600x1100x740	1 380,-

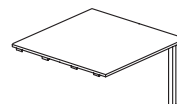

STOŁY KONFERENCYJNE Z PRZEWIESZENIEM

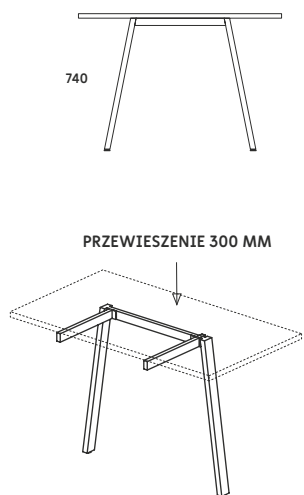

STELAŻ TYPU: DUO-A
 PROFIL: PROSTOKĄTNY 50X25 MM
 PROFIL ŁĄCZNYNY: 60X20 MM
 REGULACJA POZIOMUJĄCA: +/- 10 MM

STÓŁ KONFERENCYJNY DUO-A

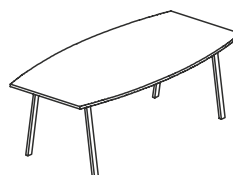
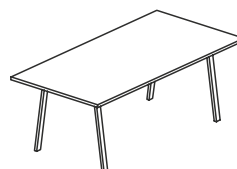
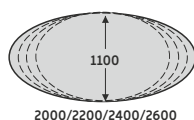
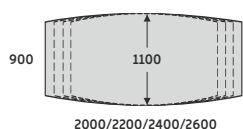
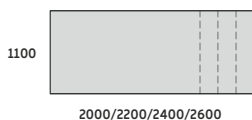

DUO-A	
AD-SKP01 2000x1100x740	1 390,-
AD-SKP02 2200x1100x740	1 459,-
AD-SKP03 2400x1100x740	1 530,-
AD-SKP04 2600x1100x740	1 609,-

DUO-A	
AD-SKB01 2000x900/1100x740	1 540,-
AD-SKB02 2200x900/1100x740	1 603,-
AD-SKB03 2400x900/1100x740	1 665,-
AD-SKB04 2600x900/1100x740	1 748,-

DUO-A	
AD-SKE01 2000x1100x740	1 497,-
AD-SKE02 2200x1100x740	1 545,-
AD-SKE03 2400x1100x740	1 612,-
AD-SKE04 2600x1100x740	1 660,-

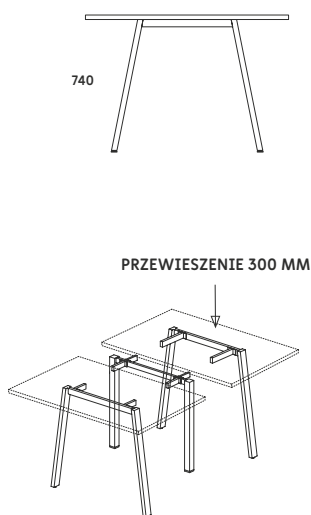

STELAŻ TYPU: DUO-A
 PROFIL: PROSTOKĄTNY 50X25 MM
 PROFIL ŁĄCZNYNY: 60X20 MM
 PROFIL NOGI ŚRODKOWEJ: 40X40 MM
 REGULACJA POZIOMUJĄCA: +/- 10 MM

STÓŁ KONFERENCYJNY DUO-A

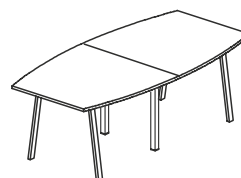
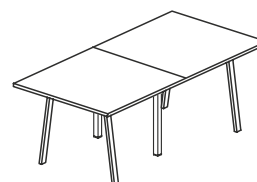
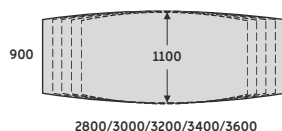
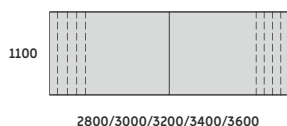

DUO-A	
AD-SKP05 2800x1100x740	1 805,-
AD-SKP06 3000x1100x740	1 895,-
AD-SKP07 3200x1100x740	1 990,-
AD-SKP08 3400x1100x740	2 089,-
AD-SKP09 3600x1100x740	2 180,-

DUO-A	
AD-SKB05 2800x900/1100x740	1 890,-
AD-SKB06 3000x900/1100x740	1 984,-
AD-SKB07 3200x900/1100x740	2 016,-
AD-SKB08 3400x900/1100x740	2 116,-
AD-SKB09 3600x900/1100x740	2 200,-

MODUŁ ROZSZERZAJĄCY

SR-P01 1000x1100x740	1 235,-
SR-P02 1200x1100x740	1 258,-
SR-P03 1400x1100x740	1 310,-
SR-P04 1600x1100x740	1 380,-

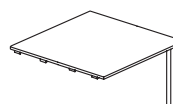

STOŁY KONFERENCYJNE Z PRZEWIESZENIEM

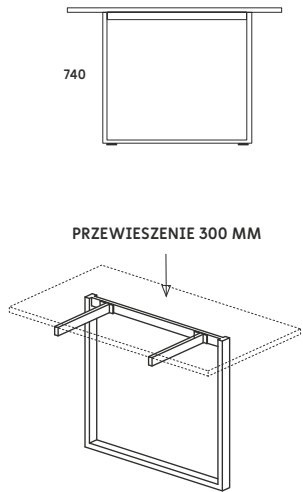

PRZEWIESZENIE 300 MM

STELAŻ TYPU: DUO-O
PROFIL: PROSTOKĄTNY 50X25 MM
PROFIL ŁĄCZNY: 60X20 MM
REGULACJA POZIOMUJĄCA: +/- 10 MM

STÓŁ KONFERENCYJNY DUO-O

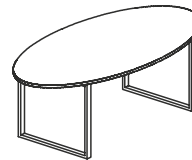
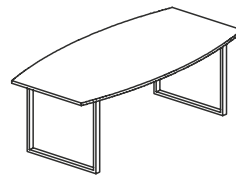
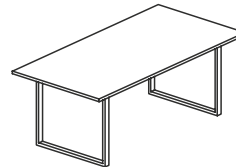
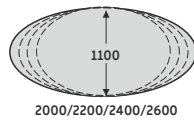
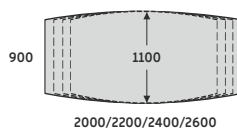

DUO-O

OD-SKP01 2000x1100x740	1 500,-
OD-SKP02 2200x1100x740	1 575,-
OD-SKP03 2400x1100x740	1 653,-
OD-SKP04 2600x1100x740	1 730,-

DUO-O

OD-SKB01 2000x900/1100x740	1 650,-
OD-SKB02 2200x900/1100x740	1 711,-
OD-SKB03 2400x900/1100x740	1 779,-
OD-SKB04 2600x900/1100x740	1 850,-

DUO-O

OD-SKE01 2000x1100x740	1 640,-
OD-SKE02 2200x1100x740	1 710,-
OD-SKE03 2400x1100x740	1 795,-
OD-SKE04 2600x1100x740	1 848,-

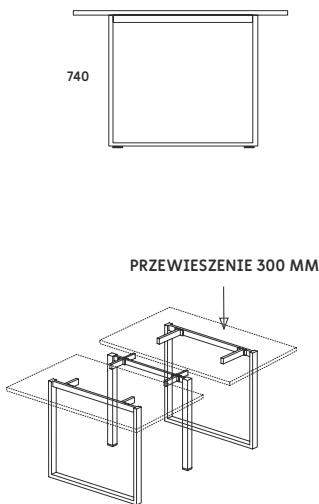

PRZEWIESZENIE 300 MM

STELAŻ TYPU: DUO-O
PROFIL: PROSTOKĄTNY 50X25 MM
PROFIL ŁĄCZNY: 60X20 MM
PROFIL NOGI ŚRODKOWEJ: 40X40 MM
REGULACJA POZIOMUJĄCA: +/- 10 MM

STÓŁ KONFERENCYJNY DUO-O

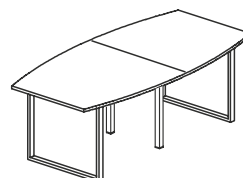
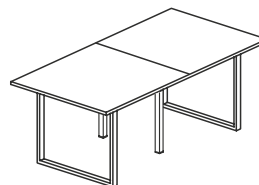
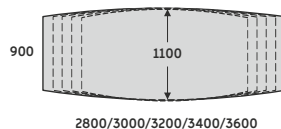
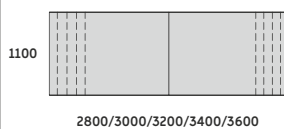

DUO-O

OD-SKP05 2800x1100x740	1 900,-
OD-SKP06 3000x1100x740	1 995,-
OD-SKP07 3200x1100x740	2 085,-
OD-SKP08 3400x1100x740	2 190,-
OD-SKP09 3600x1100x740	2 290,-

DUO-O

OD-SKB05 2800x900/1100x740	1 950,-
OD-SKB06 3000x900/1100x740	2 045,-
OD-SKB07 3200x900/1100x740	2 144,-
OD-SKB08 3400x900/1100x740	2 248,-
OD-SKB09 3600x900/1100x740	2 340,-

MODUŁ ROZSZERZAJĄCY

SR-P01 1000x1100x740	1 235,-
SR-P02 1200x1100x740	1 258,-
SR-P03 1400x1100x740	1 310,-
SR-P04 1600x1100x740	1 380,-

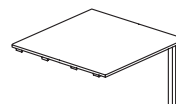

STOŁY KONFERENCYJNE Z PRZEWIESZENIEM

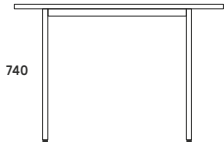

740

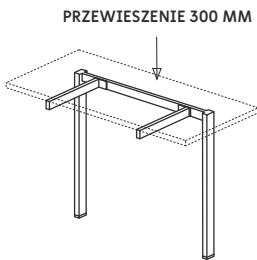

PRZEWIESZENIE 300 MM

STELAŻ TYPU: DUO-N
PROFIL: PROSTOKĄTNY 60X20 MM
PROFIL ŁĄCZNY: 40X20 MM
REGULACJA POZIOMUJĄCA: +/- 10 MM

STÓŁ KONFERENCYJNY DUO-N



1100

2000/2200/2400/2600

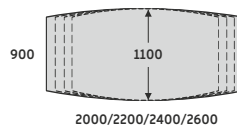

900

2000/2200/2400/2600

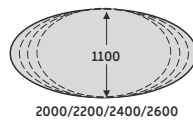

1100

2000/2200/2400/2600

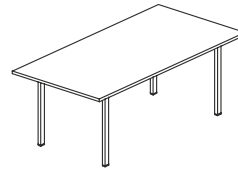

DUO-N

ND-SKP01 2000x1100x740	1 400,-
ND-SKP02 2200x1100x740	1 470,-
ND-SKP03 2400x1100x740	1 540,-
ND-SKP04 2600x1100x740	1 620,-

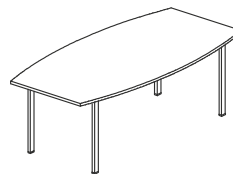

DUO-N

ND-SKB01 2000x900/1100x740	1 500,-
ND-SKB02 2200x900/1100x740	1 567,-
ND-SKB03 2400x900/1100x740	1 634,-
ND-SKB04 2600x900/1100x740	1 710,-

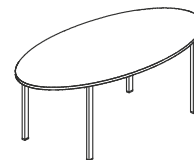

DUO-N

ND-SKE01 2000x1100x740	1 515,-
ND-SKE02 2200x1100x740	1 554,-
ND-SKE03 2400x1100x740	1 624,-
ND-SKE04 2600x1100x740	1 672,-

STÓŁ KONFERENCYJNY DUO-N

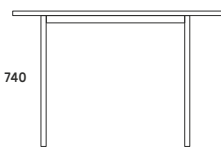

740

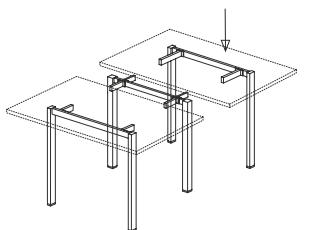

PRZEWIESZENIE 300 MM

STELAŻ TYPU: DUO-N
PROFIL: PROSTOKĄTNY: 60X20 MM
PROFIL ŁĄCZNY: 40X20 MM
PROFIL NOGI ŚRODKOWEJ: 40X40 MM
REGULACJA POZIOMUJĄCA: +/- 10 MM

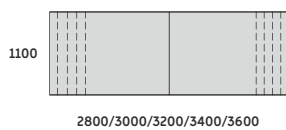

1100

2800/3000/3200/3400/3600

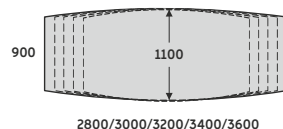

900

2800/3000/3200/3400/3600

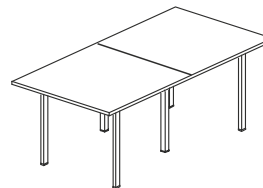

DUO-N

ND-SKP05 2800x1100x740	1 738,-
ND-SKP06 3000x1100x740	1 824,-
ND-SKP07 3200x1100x740	1 908,-
ND-SKP08 3400x1100x740	2 004,-
ND-SKP09 3600x1100x740	2 098,-

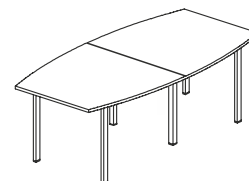

DUO-N

ND-SKB05 2800x900/1100x740	1 800,-
ND-SKB06 3000x900/1100x740	1 890,-
ND-SKB07 3200x900/1100x740	1 985,-
ND-SKB08 3400x900/1100x740	2 083,-
ND-SKB09 3600x900/1100x740	2 188,-

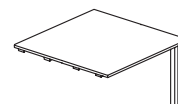

MODUŁ ROZSZERZAJĄCY

SR-P01 1000x1100x740	1 235,-
SR-P02 1200x1100x740	1 258,-
SR-P03 1400x1100x740	1 310,-
SR-P04 1600x1100x740	1 380,-

STÓŁY KONFERENCYJNE BEZ PRZEWIESZENIA



740

STÓŁ KONFERENCYJNY KWADRATOWE DUO-C

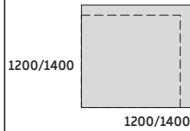

1200/1400

1200/1400

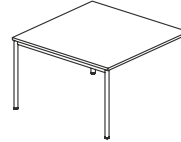

DUO-C

CD-SKP1201 1200x1200x740	1 190,-
CD-SKP1402 1400x1400x740	1 340,-

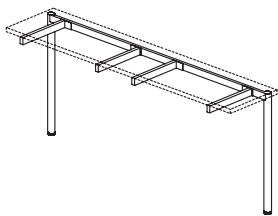

STÓŁ KONFERENCYJNY PROSTOKĄTNE DUO-C

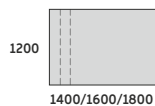

1200

1400/1600/1800

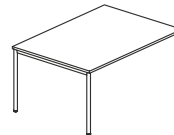

DUO-C

CD-SKP1202 1400x1200x740	1 110,-
CD-SKP1203 1600x1200x740	1 354,-
CD-SKP1204 1800x1200x740	1 384,-

STELAŻ TYPU: DUO-C
PROFIL: OKRĄGŁY Ø40 MM
PROFIL ŁĄCZNY: 40X20 MM
REGULACJA POZIOMUJĄCA: +/- 10 MM

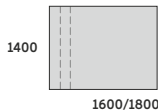

1400

1600/1800

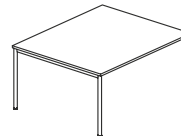

DUO-C

CD-SKP1403 1600x1400x740	1 383,-
CD-SKP1404 1800x1400x740	1 410,-



740

STÓŁ KONFERENCYJNY KWADRATOWE DUO-C Z PRZEPUSTEM KABLOWYM

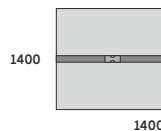

1400

1400

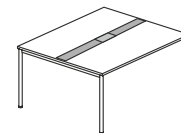

DUO-C

CD-SKP1402/W 1400x1400x740	1 353,-
CD-SKP1603/W 1600x1600x740	1 488,-

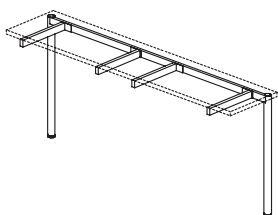

STÓŁ KONFERENCYJNY PROSTOKĄTNE DUO-C Z PRZEPUSTEM KABLOWYM

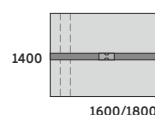

1400

1600/1800

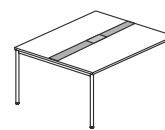

DUO-C

CD-SKP1403/W 1600x1400x740	1 422,-
CD-SKP1404/W 1800x1400x740	1 450,-

STELAŻ TYPU: DUO-C
PRZEPUST KABLOWY
PROFIL: OKRĄGŁY Ø40 MM
PROFIL ŁĄCZNY: 40X20 MM
REGULACJA POZIOMUJĄCA: +/- 10 MM

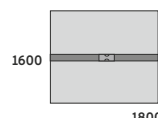

1600

1800

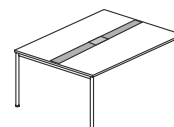

DUO-C

CD-SKP1604/W 1800x1600x740	1 490,-
----------------------------	---------

STOŁY KONFERENCYJNE BEZ PRZEWIESZENIA

STÓŁ KONFERENCYJNY PROSTOKĄTNE ŁĄCZONE DUO-C

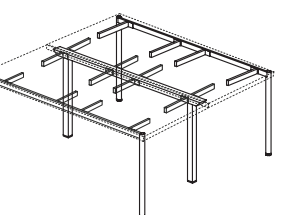

STELAŻ TYPU: DUO-C
PROFIL: OKRĄGŁY Ø40 MM
PROFIL ŁĄCZNYNY: 40X20 MM
PROFIL NOGI ŚRODKOWEJ: 40X40 MM
REGULACJA POZIOMUJĄCA: +/- 10 MM

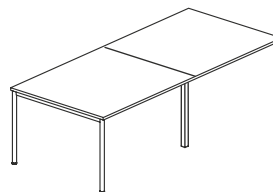
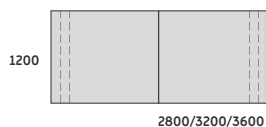

DUO-C		
CD-SKP1209	2800x1200x740	1 840,-
CD-SKP1211	3200x1200x740	2 012,-
CD-SKP1213	3600x1200x740	2 198,-

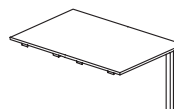

MODUŁ ROZSZERZAJĄCY		
SR-B1201	1000x1200x740	1 242,-
SR-B1202	1200x1200x740	1 266,-
SR-B1203	1400x1200x740	1 315,-
SR-B1204	1600x1200x740	1 385,-

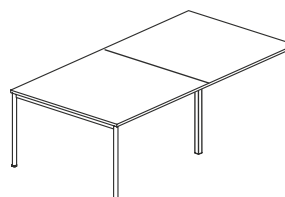
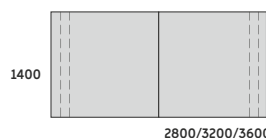

DUO-C		
CD-SKP1409	2800x1400x740	1 872,-
CD-SKP1411	3200x1400x740	2 051,-
CD-SKP1413	3600x1400x740	2 240,-

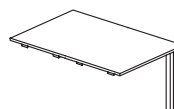

MODUŁ ROZSZERZAJĄCY		
SR-B1401	1000x1400x740	1 273,-
SR-B1402	1200x1400x740	1 299,-
SR-B1403	1400x1400x740	1 356,-
SR-B1404	1600x1400x740	1 424,-

STÓŁ KONFERENCYJNY DUO-C Z PRZEPUSTEM KABLOWYM

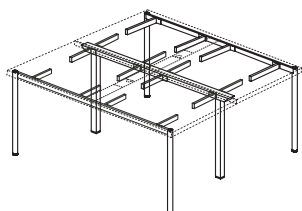

STELAŻ TYPU: DUO-C
PRZEPUST KABLOWY
PROFIL: OKRĄGŁY Ø40 MM
PROFIL ŁĄCZNYNY: 40X20 MM
PROFIL NOGI ŚRODKOWEJ: 40X40 MM
REGULACJA POZIOMUJĄCA: +/- 10 MM

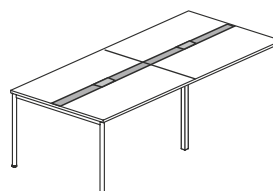
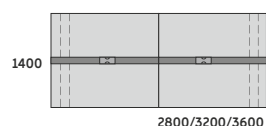

DUO-C		
CD-SKP1409/W	2800x1400x740	1 890,-
CD-SKP1411/W	3200x1400x740	2 080,-
CD-SKP1413/W	3600x1400x740	2 270,-

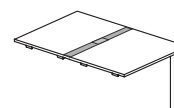

MODUŁ ROZSZERZAJĄCY		
SR-B1401/W	1000x1400x740	1 308,-
SR-B1402/W	1200x1400x740	1 338,-
SR-B1403/W	1400x1400x740	1 397,-
SR-B1404/W	1600x1400x740	1 480,-

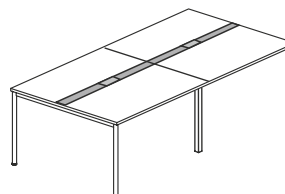
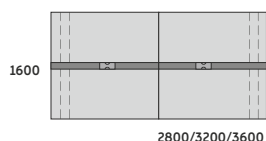

DUO-C		
CD-SKP1609/W	2800x1600x740	1 925,-
CD-SKP1611/W	3200x1600x740	2 187,-
CD-SKP1613/W	3600x1600x740	2 302,-

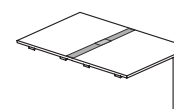

MODUŁ ROZSZERZAJĄCY		
SR-B1601/W	1000x1600x740	1 320,-
SR-B1602/W	1200x1600x740	1 360,-
SR-B1603/W	1400x1600x740	1 450,-
SR-B1604/W	1600x1600x740	1 500,-

STÓŁY KONFERENCYJNE BEZ PRZEWIESZENIA



740

STÓŁ KONFERENCYJNY KWADRATOWE DUO-U

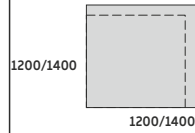

1200/1400

1200/1400

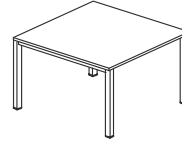

DUO-U

UD-SKP1201	1200x1200x740	1 385,-
UD-SKP1402	1400x1400x740	1 450,-

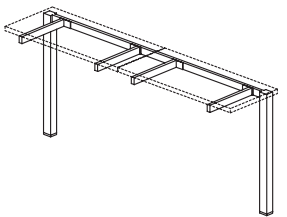

STELAŻ TYPU: DUO-U
PROFIL: KWADRATOWY 50x50 MM
PROFIL ŁĄCZNY: 40x20 MM
REGULACJA POZIOMUJĄCA: +/- 10 MM

STÓŁ KONFERENCYJNY PROSTOKĄTNE DUO-U

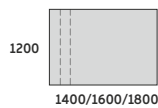

1200

1400/1600/1800

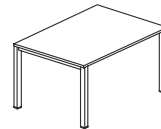

DUO-U

UD-SKP1202	1400x1200x740	1 470,-
UD-SKP1203	1600x1200x740	1 510,-
UD-SKP1204	1800x1200x740	1 590,-

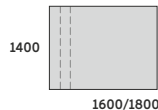

1400

1600/1800

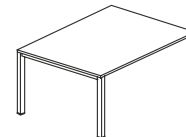

DUO-U

UD-SKP1403	1600x1400x740	1 520,-
UD-SKP1404	1800x1400x740	1 550,-



740

STÓŁ KONFERENCYJNY KWADRATOWE DUO-U Z PRZEPUSTEM KABLOWYM

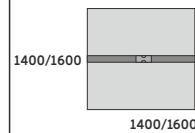

1400/1600

1400/1600

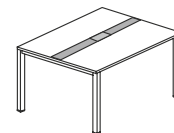

DUO-U

UD-SKP1402/W	1400x1400x740	1 500,-
UD-SKP1603/W	1600x1600x740	1 600,-

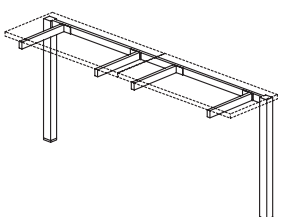

STELAŻ TYPU: DUO-U
PRZEPUST KABLOWY
PROFIL: KWADRATOWY 50x50 MM
PROFIL ŁĄCZNY: 40x20 MM
REGULACJA POZIOMUJĄCA: +/- 10 MM
STAŁA WYSOKOŚĆ: 740 MM

STÓŁ KONFERENCYJNY PROSTOKĄTNE DUO-U Z PRZEPUSTEM KABLOWYM

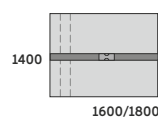

1400

1600/1800

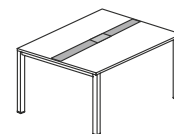

DUO-U

UD-SKP1403/W	1600x1400x740	1 580,-
UD-SKP1404/W	1800x1400x740	1 620,-

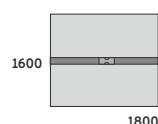

1600

1800

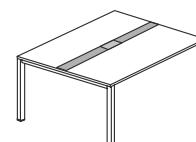

DUO-U

UD-SKP1604/W	1800x1600x740	1 740,-
--------------	---------------	---------

STÓŁY KONFERENCYJNE BEZ PRZEWIESZENIA

STÓŁ KONFERENCYJNY PROSTOKĄTNE ŁĄCZONE DUO-U

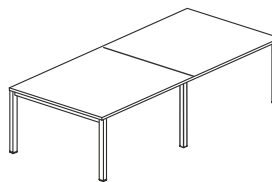
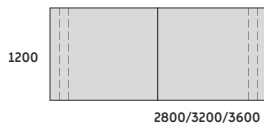

DUO-U		
UD-SKP1209	2800x1200x740	2 000,-
UD-SKP1211	3200x1200x740	2 200,-
UD-SKP1213	3600x1200x740	2 300,-

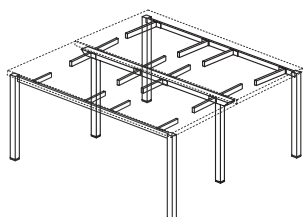

STELAŻ TYPU: DUO-U
PROFIL: KWADRATOWY 50x50 MM
PROFIL ŁĄCZYNY: 40x20 MM
PROFIL NOGI ŚRODKOWEJ: 40x40 MM
REGULACJA POZIOMUJĄCA: +/- 10 MM

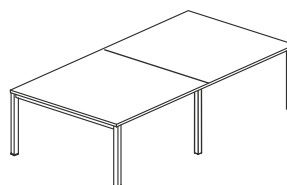
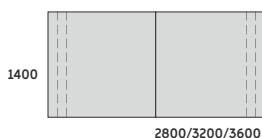

MODUŁ ROZSZERZAJĄCY		
SR-B1201	1000x1200x740	1 242,-
SR-B1202	1200x1200x740	1 266,-
SR-B1203	1400x1200x740	1 315,-
SR-B1204	1600x1200x740	1 385,-

DUO-U		
UD-SKP1409	2800x1400x740	1 980,-
UD-SKP1411	3200x1400x740	2 250,-
UD-SKP1413	3600x1400x740	2 400,-

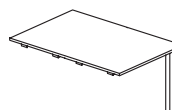

MODUŁ ROZSZERZAJĄCY		
SR-B1401	1000x1400x740	1 273,-
SR-B1402	1200x1400x740	1 299,-
SR-B1403	1400x1400x740	1 356,-
SR-B1404	1600x1400x740	1 424,-

STÓŁ KONFERENCYJNY DUO-U Z PRZEPUSTEM KABLOWYM

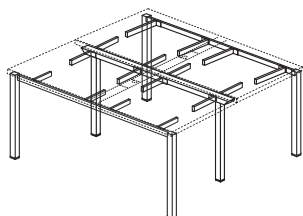

STELAŻ TYPU: DUO-U
PRZEPUST KABLOWY
PROFIL: KWADRATOWY 50x50 MM
PROFIL ŁĄCZYNY: 40x20 MM
PROFIL NOGI ŚRODKOWEJ: 40x40 MM
REGULACJA POZIOMUJĄCA: +/- 10 MM

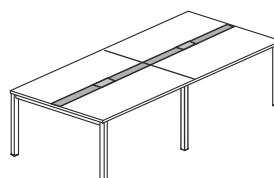

DUO-U		
UD-SKP1409/W	2800x1400x740	2 070,-
UD-SKP1411/W	3200x1400x740	2 280,-
UD-SKP1413/W	3600x1400x740	2 360,-

MODUŁ ROZSZERZAJĄCY		
SR-B1401/W	1000x1400x740	1 308,-
SR-B1402/W	1200x1400x740	1 338,-
SR-B1403/W	1400x1400x740	1 397,-
SR-B1404/W	1600x1400x740	1 480,-

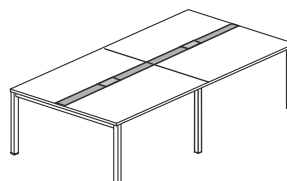
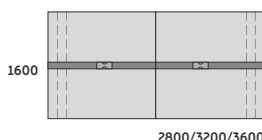

DUO-U		
UD-SKP1609/W	2800x1600x740	2 300,-
UD-SKP1611/W	3200x1600x740	2 380,-
UD-SKP1613/W	3600x1600x740	2 450,-

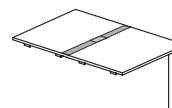

MODUŁ ROZSZERZAJĄCY		
SR-B1601/W	1000x1600x740	1 320,-
SR-B1602/W	1200x1600x740	1 360,-
SR-B1603/W	1400x1600x740	1 450,-
SR-B1604/W	1600x1600x740	1 500,-

STÓŁY KONFERENCYJNE BEZ PRZEWIESZENIA

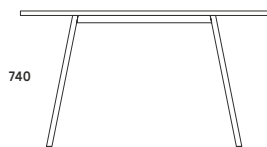

740

STÓŁ KONFERENCYJNY KWADRATOWE DUO-A

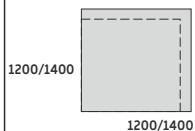

1200/1400

1200/1400

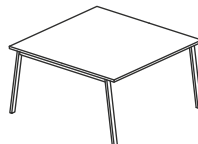

DUO-A		
AD-SKP1201	1200x1200x740	1 330,-
AD-SKP1402	1400x1400x740	1 435,-

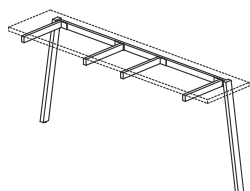

STELAŻ TYPU: DUO-A
PROFIL: PROSTOKĄTNY 50X25 MM
PROFIL ŁĄCZNYNY: 40X20 MM
REGULACJA POZIOMUJĄCA: +/- 10 MM

STÓŁ KONFERENCYJNY PROSTOKĄTNE DUO-A

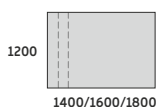

1200

1400/1600/1800

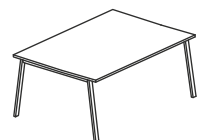

DUO-A		
AD-SKP1202	1400x1200x740	1 368,-
AD-SKP1203	1600x1200x740	1 440,-
AD-SKP1204	1800x1200x740	1 464,-

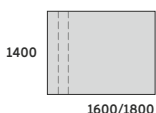

1400

1600/1800

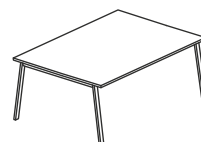

DUO-A		
AD-SKP1403	1600x1400x740	1 470,-
AD-SKP1404	1800x1400x740	1 510,-

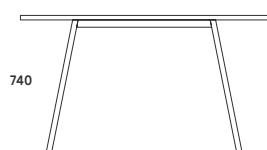

740

STÓŁ KONFERENCYJNY KWADRATOWE DUO-A

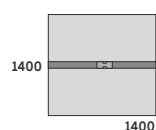

1400

1400

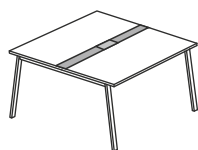

DUO-A		
AD-SKP1402/W	1400x1400x740	1 450,-
AD-SKP1603/W	1600x1600x740	1 540,-

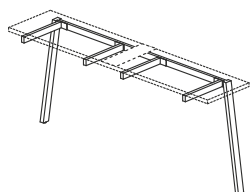

STELAŻ TYPU: DUO-A
PRZEPUST KABLOWY
PROFIL: PROSTOKĄTNY 50X25 MM
PROFIL ŁĄCZNYNY: 40X20 MM
REGULACJA POZIOMUJĄCA: +/- 10 MM

STÓŁ KONFERENCYJNY PROSTOKĄTNE DUO-A Z PRZEPUSTEM KABLOWYM

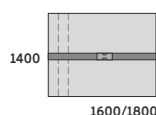

1400

1600/1800

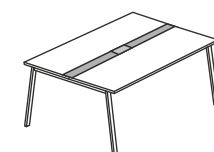

DUO-A		
AD-SKP1403/W	1600x1400x740	1 520,-
AD-SKP1404/W	1800x1400x740	1 580,-

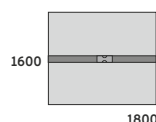

1600

1800

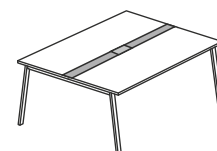

DUO-A		
AD-SKP1604/W	1800x1600x740	1 620,-

STOŁY KONFERENCYJNE BEZ PRZEWIESZENIA

STÓŁ KONFERENCYJNY PROSTOKĄTNE ŁĄCZONE DUO-A

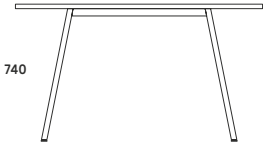

740

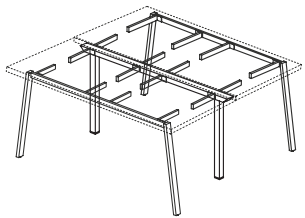

STELAŻ TYPU: DUO-A
PROFIL: PROSTOKĄTNY 50X25 MM
PROFIL ŁĄCZNYNY: 40X20 MM
PROFIL NOGI ŚRODKOWEJ: 40X40 MM
REGULACJA POZIOMUJĄCA: +/- 10 MM

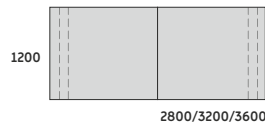

1200

2800/3200/3600

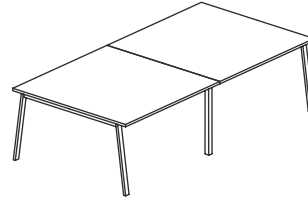

DUO-A

AD-SKP1209	2800x1200x740	1 914,-
AD-SKP1211	3200x1200x740	2 140,-
AD-SKP1213	3600x1200x740	2 211,-

MODUŁ ROZSZERZAJĄCY

SR-B1201	1000x1200x740	1 242,-
SR-B1202	1200x1200x740	1 266,-
SR-B1203	1400x1200x740	1 315,-
SR-B1204	1600x1200x740	1 385,-



1400

2800/3200/3600

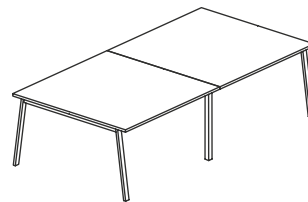

DUO-A

AD-SKP1409	2800x1400x740	1 931,-
AD-SKP1411	3200x1400x740	2 160,-
AD-SKP1413	3600x1400x740	2 333,-

MODUŁ ROZSZERZAJĄCY

SR-B1401	1000x1400x740	1 273,-
SR-B1402	1200x1400x740	1 299,-
SR-B1403	1400x1400x740	1 356,-
SR-B1404	1600x1400x740	1 424,-

STÓŁ KONFERENCYJNY DUO-A Z PRZEPUSTEM KABLOWYM

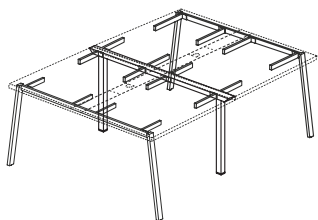

STELAŻ TYPU: DUO-A
PRZEPUST KABLOWY
PROFIL: PROSTOKĄTNY 50X25 MM
PROFIL ŁĄCZNYNY: 40X20 MM
PROFIL NOGI ŚRODKOWEJ: 40X40 MM
REGULACJA POZIOMUJĄCA: +/- 10 MM

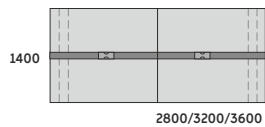

1400

2800/3200/3600

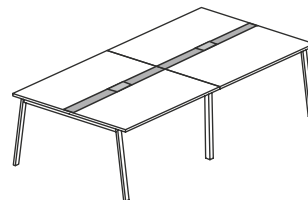

DUO-A

AD-SKP1409/W	2800x1400x740	1 949,-
AD-SKP1411/W	3200x1400x740	2 149,-
AD-SKP1413/W	3600x1400x740	2 350,-

MODUŁ ROZSZERZAJĄCY

SR-B1401/W	1000x1400x740	1 308,-
SR-B1402/W	1200x1400x740	1 338,-
SR-B1403/W	1400x1400x740	1 397,-
SR-B1404/W	1600x1400x740	1 480,-

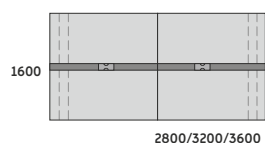

1600

2800/3200/3600

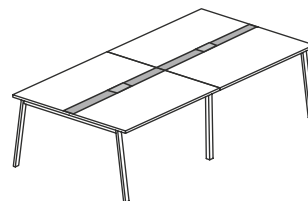

DUO-A

AD-SKP1609/W	2800x1600x740	2 060,-
AD-SKP1611/W	3200x1600x740	2 200,-
AD-SKP1613/W	3600x1600x740	2 400,-

MODUŁ ROZSZERZAJĄCY

SR-B1601/W	1000x1600x740	1 320,-
SR-B1602/W	1200x1600x740	1 360,-
SR-B1603/W	1400x1600x740	1 450,-
SR-B1604/W	1600x1600x740	1 500,-

STÓŁY KONFERENCYJNE BEZ PRZEWIESZENIA

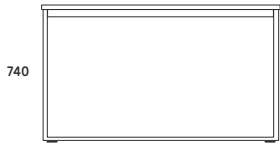

STÓŁ KONFERENCYJNY KWADRATOWE DUO-O

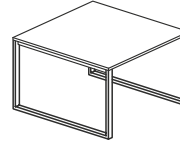
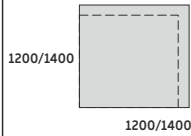

DUO-O	
OD-SKP1201 1200x1200x740	1 400,-
OD-SKP1402 1400x1400x740	1 478,-

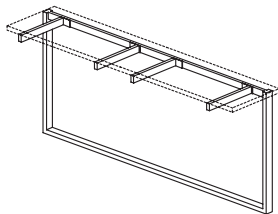

STÓŁ KONFERENCYJNY PROSTOKĄTNE DUO-O

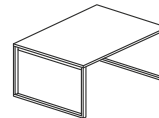
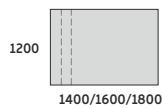

DUO-O	
OD-SKP1202 1400x1200x740	1 500,-
OD-SKP1203 1600x1200x740	1 540,-
OD-SKP1204 1800x1200x740	1 640,-

STELAŻ TYPU: DUO-O
PROFIL: PROSTOKĄTNY 50X25 MM
PROFIL ŁĄCZNY: 40X20 MM
REGULACJA POZIOMUJĄCA: +/- 10 MM

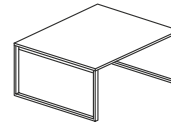
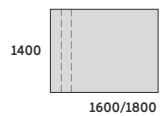

DUO-O	
OD-SKP1403 1600x1400x740	1 568,-
OD-SKP1404 1800x1400x740	1 700,-

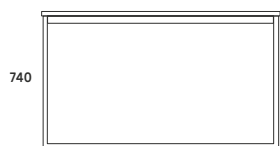

STÓŁ KONFERENCYJNY KWADRATOWE DUO-O Z PRZEPUSTEM KABLOWYM

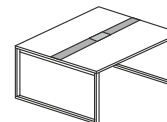
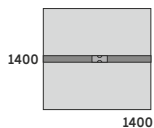

DUO-O	
OD-SKP1402/W 1400x1400x740	1 553,-
OD-SKP1603/W 1600x1600x740	1 630,-

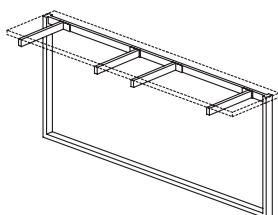

STÓŁ KONFERENCYJNY PROSTOKĄTNE DUO-O Z PRZEPUSTEM KABLOWYM

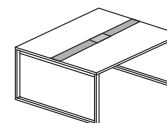
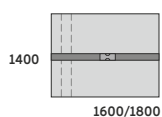

DUO-O	
OD-SKP1403/W 1600x1400x740	1 620,-
OD-SKP1404/W 1800x1400x740	1 650,-

STELAŻ TYPU: DUO-O
PRZEPUST KABLOWY
PROFIL: PROSTOKĄTNY 50X25 MM
PROFIL ŁĄCZNY: 40X20 MM
REGULACJA:
POZIOMUJĄCA W ZAKRESIE +/- 10 MM

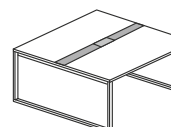
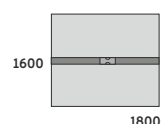

DUO-O	
OD-SKP1604/W 1800x1600x740	1 750,-

STOŁY KONFERENCYJNE BEZ PRZEWIESZENIA

STÓŁ KONFERENCYJNY PROSTOKĄTNE ŁĄCZONE DUO-O



740

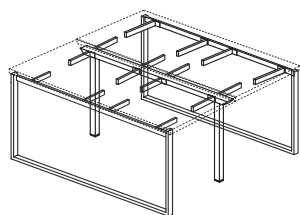

STELAŻ TYPU: DUO-O
PROFIL: PROSTOKĄTNY 50X25 MM
PROFIL ŁĄCZYNY: 40X20 MM
PROFIL NOGI ŚRODKOWEJ: 40X40 MM
REGULACJA POZIOMUJĄCA: +/- 10 MM

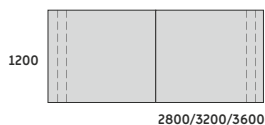

1200

2800/3200/3600

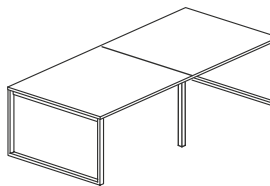

DUO-O		
OD-SKP1209	2800x1200x740	2 033,-
OD-SKP1211	3200x1200x740	2 233,-
OD-SKP1213	3600x1200x740	2 450,-

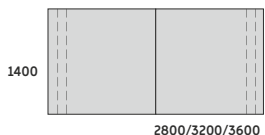

1400

2800/3200/3600

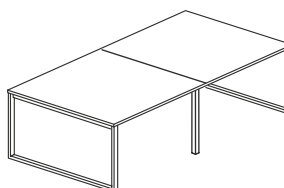

MODUŁ ROZSZERZAJĄCY		
SR-B1201	1000x1200x740	1 242,-
SR-B1202	1200x1200x740	1 266,-
SR-B1203	1400x1200x740	1 315,-
SR-B1204	1600x1200x740	1 385,-

DUO-O		
OD-SKP1409	2800x1400x740	2 052,-
OD-SKP1411	3200x1400x740	2 255,-
OD-SKP1413	3600x1400x740	2 473,-

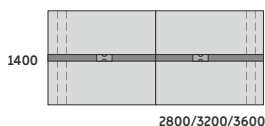

1400

2800/3200/3600

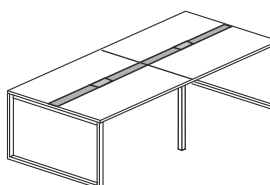

DUO-O		
OD-SKP1409/W	2800x1400x740	2 093,-
OD-SKP1411/W	3200x1400x740	2 300,-
OD-SKP1413/W	3600x1400x740	2 346,-

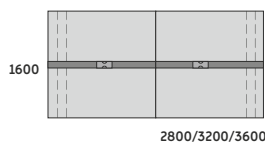

1600

2800/3200/3600

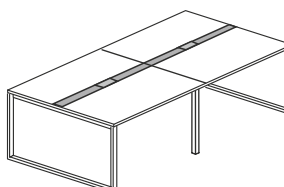

MODUŁ ROZSZERZAJĄCY		
SR-B1401/W	1000x1400x740	1 308,-
SR-B1402/W	1200x1400x740	1 338,-
SR-B1403/W	1400x1400x740	1 397,-
SR-B1404/W	1600x1400x740	1 480,-

DUO-O		
OD-SKP1609/W	2800x1600x740	2 198,-
OD-SKP1611/W	3200x1600x740	2 420,-
OD-SKP1613/W	3600x1600x740	2 463,-

STÓŁ KONFERENCYJNY DUO-O Z PRZEPUSTEM KABLOWYM

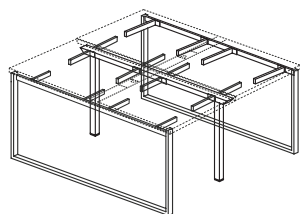

STELAŻ TYPU: DUO-O
PRZEPUST KABLOWY
PROFIL: PROSTOKĄTNY 50X25 MM
PROFIL ŁĄCZYNY: 40X20 MM
PROFIL NOGI ŚRODKOWEJ: 40X40 MM
REGULACJA POZIOMUJĄCA: +/- 10 MM

MODUŁ ROZSZERZAJĄCY		
SR-B1601/W	1000x1600x740	1 320,-
SR-B1602/W	1200x1600x740	1 360,-
SR-B1603/W	1400x1600x740	1 450,-
SR-B1604/W	1600x1600x740	1 500,-

STÓŁY KONFERENCYJNE BEZ PRZEWIESZENIA



STÓŁ KONFERENCYJNY KWADRATOWE DUO-N

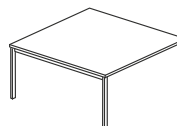
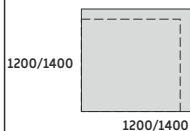

DUO-N	
ND-SKP01 1200x1200x740	1 372,-
ND-SKP02 1400x1400x740	1 430,-

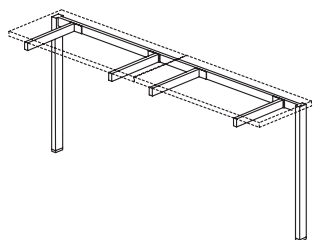

STÓŁ KONFERENCYJNY PROSTOKĄTNE DUO-N

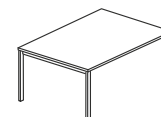
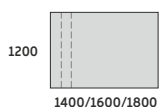

DUO-N	
ND-SKP01 1400x1200x740	1 450,-
ND-SKP02 1600x1200x740	1 490,-
ND-SKP03 1800x1200x740	1 550,-

STELAŻ TYPU: DUO-N
PROFIL: PROSTOKĄTNY 50X25 MM
PROFIL ŁĄCZYNY: 40X20 MM PROFIL
REGULACJA POZIOMUJĄCA: +/- 10 MM

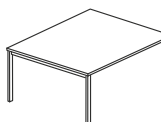
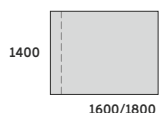

DUO-N	
ND-SKP01 1600x1400x740	1 490,-
ND-SKP02 1800x1400x740	1 520,-

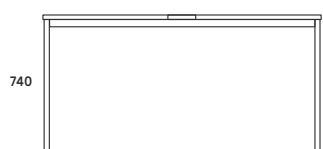

STÓŁ KONFERENCYJNY KWADRATOWE DUO-N

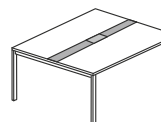
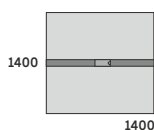

DUO-N	
ND-SKP01 1400x1400x740	1 480,-
ND-SKP02 1600x1600x740	1 520,-

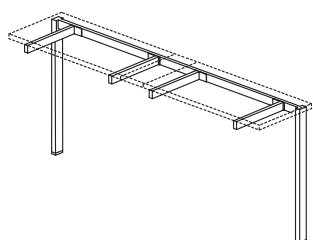

STÓŁ KONFERENCYJNY PROSTOKĄTNE DUO-N

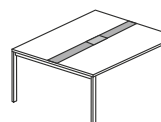
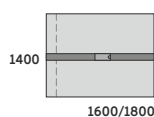

DUO-N	
ND-SKP01 1600x1400x740	1 550,-
ND-SKP02 1800x1400x740	1 588,-

STELAŻ TYPU: DUO-N
PROFIL: PROSTOKĄTNY 50X25 MM
PROFIL ŁĄCZYNY: 40X20 MM
REGULACJA POZIOMUJĄCA: +/- 10 MM

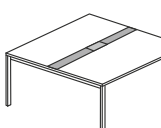
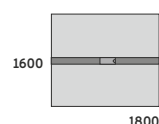

DUO-N	
ND-SKP01 1800x1600x740	1 700,-

STOŁY KONFERENCYJNE BEZ PRZEWIESZENIA

STÓŁ KONFERENCYJNY PROSTOKĄTNE ŁĄCZONE DUO-N

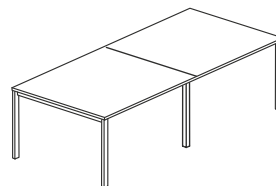
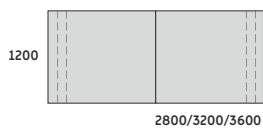

DUO-N		
ND-SKP1209	2800x1200x740	1 960,-
ND-SKP1211	3200x1200x740	2 150,-
ND-SKP1213	3600x1200x740	2 254,-

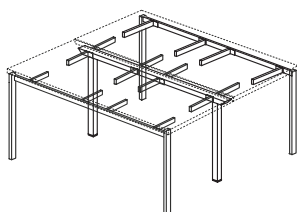

STELAŻ TYPU: DUO-N
PROFIL: PROSTOKĄTNY 50X25 MM
PROFIL ŁĄCZYNY: 40X20 MM
PROFIL NOGI ŚRODKOWEJ: 40X40 MM
REGULACJA POZIOMUJĄCA: +/- 10 MM

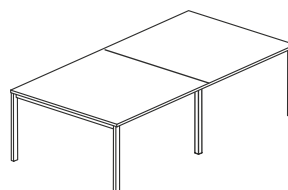
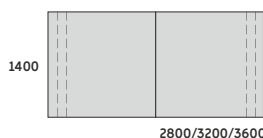

MODUŁ ROZSZERZAJĄCY		
SR-B1201	1000x1200x740	1 242,-
SR-B1202	1200x1200x740	1 266,-
SR-B1203	1400x1200x740	1 315,-
SR-B1204	1600x1200x740	1 385,-

DUO-N		
ND-SKP1409	2800x1400x740	1 940,-
ND-SKP1411	3200x1400x740	2 205,-
ND-SKP1413	3600x1400x740	2 352,-

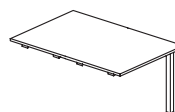

MODUŁ ROZSZERZAJĄCY		
SR-B1401	1000x1400x740	1 273,-
SR-B1402	1200x1400x740	1 299,-
SR-B1403	1400x1400x740	1 356,-
SR-B1404	1600x1400x740	1 424,-

STÓŁ KONFERENCYJNY DUO-N Z PRZEPUSTEM KABLOWYM

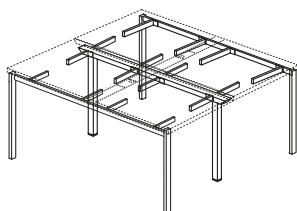

STELAŻ TYPU: DUO-N
PROFIL: PROSTOKĄTNY 50X25 MM
PROFIL ŁĄCZYNY: 40X20 MM
PROFIL NOGI ŚRODKOWEJ: 40X40 MM
REGULACJA POZIOMUJĄCA: +/- 10 MM

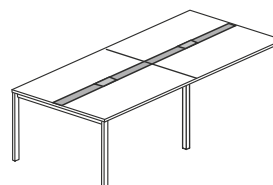
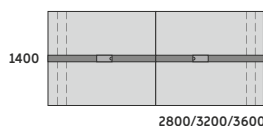

DUO-N		
ND-SKP1409/W	2800x1400x740	2 030,-
ND-SKP1411/W	3200x1400x740	2 235,-
ND-SKP1413/W	3600x1400x740	2 312,-

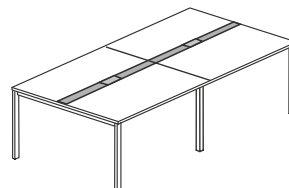
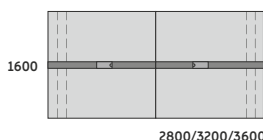

MODUŁ ROZSZERZAJĄCY		
SR-B1401/W	1000x1400x740	1 308,-
SR-B1402/W	1200x1400x740	1 338,-
SR-B1403/W	1400x1400x740	1 397,-
SR-B1404/W	1600x1400x740	1 480,-

DUO-N		
ND-SKP1609/W	2800x1600x740	2 254,-
ND-SKP1611/W	3200x1600x740	2 330,-
ND-SKP1613/W	3600x1600x740	2 402,-

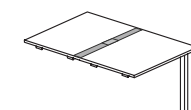

MODUŁ ROZSZERZAJĄCY		
SR-B1601/W	1000x1600x740	1 320,-
SR-B1602/W	1200x1600x740	1 360,-
SR-B1603/W	1400x1600x740	1 450,-
SR-B1604/W	1600x1600x740	1 500,-

STOLIKI OKOLICZNOŚCIOWE H550

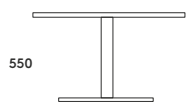

550

STOLIK OKOLICZNOŚCIOWY H550 PODSTAWA KWADRATOWA

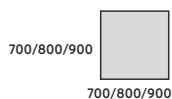

700/800/900

700/800/900

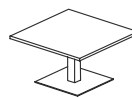

STOLIK OKOLICZNOŚCIOWY

SKMK-501 700x700x550	1 130,-
SKMK-502 800x800x550	1 148,-
SKMK-503 900x900x550	1 180,-

STELAŻ:
PROFIL: KWADRATOWY 80X80 MM
PODSTAWA KWADRATOWA: 490X490 MM

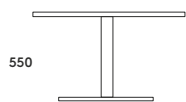

550

STOLIK OKOLICZNOŚCIOWY H550 PODSTAWA OKRĄGŁA

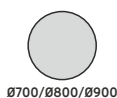

Ø700/Ø800/Ø900

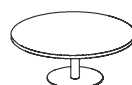

STOLIK OKOLICZNOŚCIOWY

SKMO-501 Ø700x550	1 044,-
SKMO-502 Ø800x550	1 055,-
SKMO-503 Ø900x550	1 076,-

STELAŻ:
PROFIL: KOLUMNNA Ø76 MM
PODSTAWA OKRĄGŁA: Ø490 MM

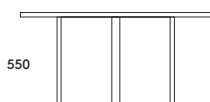

550

STOLIK OKOLICZNOŚCIOWY H550

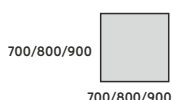

700/800/900

700/800/900

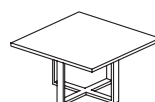

STOLIK OKOLICZNOŚCIOWY

SKMXK-501 700x700x550	791,-
SKMXK-502 800x800x550	819,-
SKMXK-503 900x900x550	848,-

STELAŻ:
PROFIL: 60X20 MM

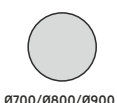

Ø700/Ø800/Ø900



STOLIK OKOLICZNOŚCIOWY

SKMXO-501 Ø700x550	802,-
SKMXO-502 Ø800x550	841,-
SKMXO-503 Ø900x550	876,-

STOLIKI OKOLICZNOŚCIOWE H740

STELAŻ:
PROFIL: KWADRATOWY 80X80 MM
PODSTAWA KWADRATOWA: 490X490 MM

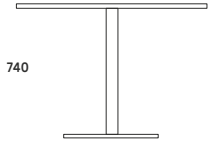

740

STELAŻ:
PROFIL: KOLUMNNA Ø76 MM
PODSTAWA OKRĄGŁA: Ø490 MM

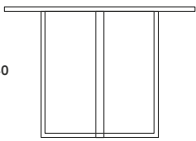

740

STELAŻ:
PROFIL: 60X20 MM

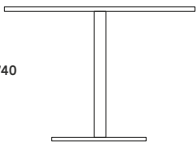

740

STELAŻ:
PROFIL: KWADRATOWY 80X80 MM
PODSTAWA KWADRATOWA: 490X490 MM

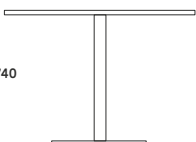

740

STELAŻ:
PROFIL: KOLUMNNA Ø76 MM
PODSTAWA OKRĄGŁA: Ø490 MM

STOLIK OKOLICZNOŚCIOWY H740 PODSTAWA KWADRATOWA

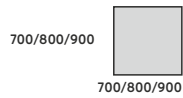

700/800/900

700/800/900

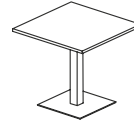

STOLIK OKOLICZNOŚCIOWY H740 PODSTAWA OKRĄGŁA



Ø700/Ø800/Ø900



STOLIK OKOLICZNOŚCIOWY H740

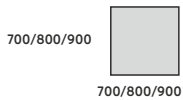

700/800/900

700/800/900

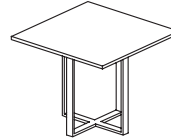

Ø700/Ø800/Ø900



STOLIK OKOLICZNOŚCIOWY

SKMK-701	700x700x740	1 192,-
SKMK-702	800x800x740	1 206,-
SKMK-703	900x900x740	1 234,-

STOLIK OKOLICZNOŚCIOWY

SKMO-701	Ø700x740	1 079,-
SKMO-702	Ø800x740	1 090,-
SKMO-703	Ø900x740	1 128,-

STOLIK OKOLICZNOŚCIOWY

SKMXK-701	700x700x740	849,-
SKMXK-702	800x800x740	882,-
SKMXK-703	900x900x740	900,-

STOLIK OKOLICZNOŚCIOWY

SKMX0-701	Ø700x740	860,-
SKMX0-702	Ø800x740	899,-
SKMX0-703	Ø900x740	933,-

STÓŁ KONFERENCYJNY H740 PODSTAWA KWADRATOWA

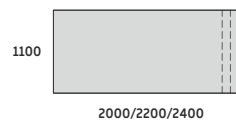

1100

2000/2200/2400

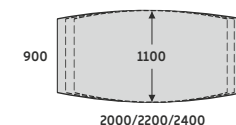
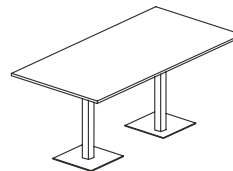

900

1100

2000/2200/2400

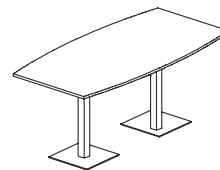

STÓŁ KONFERENCYJNY

SGKP-701	2000x1100x740	2 400,-
SGKP-702	2200x1100x740	2 440,-
SGKP-703	2400x1100x740	2 514,-

STÓŁ KONFERENCYJNY

SGKB-701	2000x900/1100x740	2 465,-
SGKB-702	2200x900/1100x740	2 505,-
SGKB-703	2400x900/1100x740	2 600,-

STÓŁ KONFERENCYJNY H740 PODSTAWA OKRĄGŁA

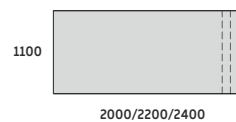

1100

2000/2200/2400

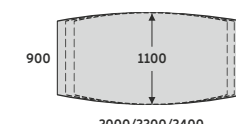
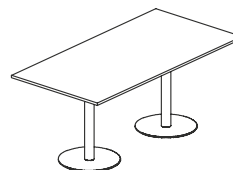

900

1100

2000/2200/2400

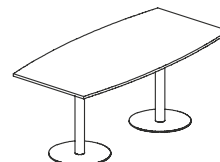

STÓŁ KONFERENCYJNY

SGOP-701	2000x1100x740	1 954,-
SGOP-702	2200x1100x740	1 985,-
SGOP-703	2400x1100x740	2 045,-

STÓŁ KONFERENCYJNY

SGOB-701	2000x900/1100x740	2 006,-
SGOB-702	2200x900/1100x740	2 035,-
SGOB-703	2400x900/1100x740	2 150,-

STOLIKI OKOLICZNOŚCIOWE H1100

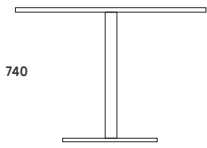

STOLIK OKOLICZNOŚCIOWY H1100
PODSTAWA KWADRATOWA

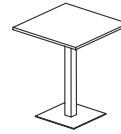
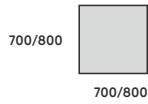

STOLIK OKOLICZNOŚCIOWY	
SKMK-101 700x700x1100	1 260,-
SKMK-102 800x800x1100	1 278,-

STELAŻ:
PROFIL: KWADRATOWY 80X80 MM
PODSTAWA KWADRATOWA: 490X490 MM

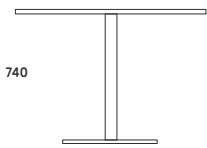

STOLIK OKOLICZNOŚCIOWY H1100
PODSTAWA OKRĄGŁA

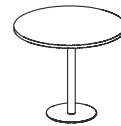
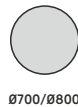

STOLIK OKOLICZNOŚCIOWY	
SKMO-101 Ø700x1100	1 150,-
SKMO-102 Ø800x1100	1 180,-

STELAŻ:
PROFIL: KOLUMNA Ø76 MM
PODSTAWA OKRĄGŁA: Ø490 MM

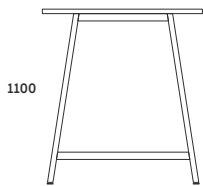

STOLIK OKOLICZNOŚCIOWY H1100

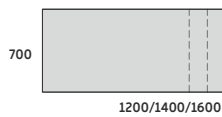

DUO 700	
NDPU-701 1200x700x1100	1 981,-
NDPU-702 1400x700x1100	2 035,-
NDPU-703 1600x700x1100	2 099,-

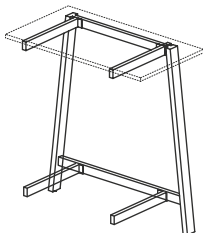

STOLIK OKOLICZNOŚCIOWY H1100

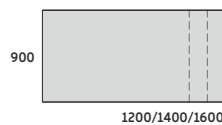

DUO 900	
NDPU-901 1200x900x1100	2 000,-
NDPU-902 1400x900x1100	2 092,-
NDPU-903 1600x900x1100	2 178,-

STELAŻ TYPU: DUO-A
PROFIL: PROSTOKĄTNY 50X25 MM
PROFIL ŁĄCZNY GÓRNEJ: 60X20 MM
PROFIL ŁĄCZNY DOLNEJ: 40X20 MM
REGULACJA POZIOMUJĄCA: +/- 10 MM

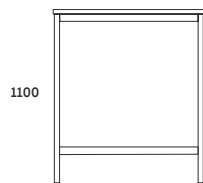

STOLIK OKOLICZNOŚCIOWY H1100

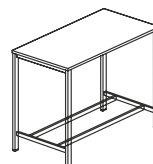
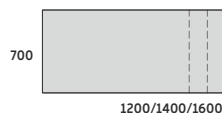

DUO 700	
NDPP-701 1200x700x1100	1 800,-
NDPP-702 1400x700x1100	1 881,-
NDPP-703 1600x700x1100	1 980,-

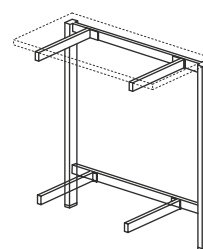

STOLIK OKOLICZNOŚCIOWY H1100

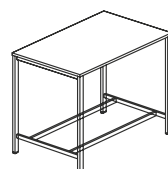
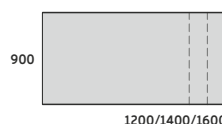

DUO 900	
NDPP-901 1200x900x1100	1 998,-
NDPP-902 1400x900x1100	2 081,-
NDPP-903 1600x900x1100	2 115,-

STELAŻ TYPU: DUO-N
PROFIL: PROSTOKĄTNY 50X25 MM
PROFIL ŁĄCZNY GÓRNEJ: 60X20 MM
PROFIL ŁĄCZNY DOLNEJ: 40X20 MM
REGULACJA POZIOMUJĄCA: +/- 10 MM

OPIS:

- TOP 18MM
- DÓŁ 18MM
- KORPUS 18MM
- FRONTY SZUFLAD 18MM
- ZAMEK CENTRALNY

KONTENERY MOBILNE

SZUFLADY PŁYTOWE

SZUFLADY METALOWE

KONTENERY MOBILNE

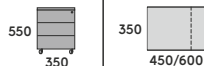

KONTENER MOBILNY
-1 WKŁAD PIÓRNIKOWY
-3 SZUFLADY PŁYTOWE

KM1S3/1 350x600x550 550,-
KM2S3/1 350x450x550 510,-

KONTENERY MOBILNE

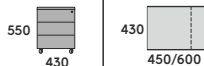

KONTENER MOBILNY
-1 WKŁAD PIÓRNIKOWY
-3 SZUFLADY PŁYTOWE

KM1S3 430x600x550 586,-
KM2S3 430x450x550 527,-

KONTENER MOBILNY
-1 WKŁAD PIÓRNIKOWY
-3 SZUFLADY METALOWE

KM1S3/M 430x600x550 1 153,-

KONTENERY MOBILNE

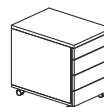
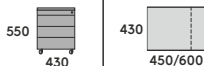

KONTENER MOBILNY
-1 SZUFLADA PŁYTOWA NISKA
Z WKŁADEM PIÓRNIKOWYM
-3 SZUFLADY PŁYTOWE

KM1S4 430x600x550 624,-
KM2S4 430x450x550 595,-

KONTENER MOBILNY
-1 SZUFLADA PIÓRNIKOWA
-3 SZUFLADY METALOWE

KM1S4/M 430x600x550 1 223,-

KONTENERY MOBILNE

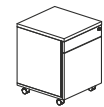
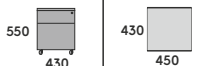

KONTENER MOBILNY
-1 SZUFLADA PŁYTOWA
-1 DRZWICZKI

KM2D2 430x450x550 420,-

KONTENERY MOBILNE

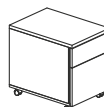
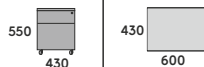

KONTENER MOBILNY
-1 SZUFLADA PŁYTOWA
-1 SZUFLADA PŁYTOWA
NA TECZKI ZAWIESZKOWE

KM1F2 430x600x550 575,-

KONTENER MOBILNY
-1 SZUFLADA METALOWA
-1 SZUFLADA METALOWA
NA TECZKI ZAWIESZKOWE

KM1F2/M 430x600x550 983,-

KONTENERY MOBILNE

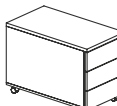
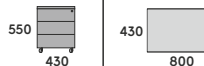

KONTENER MOBILNY
-1 WKŁAD PIÓRNIKOWY
-3 SZUFLADY PŁYTOWE

KM4S3 430x800x550 667,-

KONTENER MOBILNY
-1 WKŁAD PIÓRNIKOWY
-3 SZUFLADY METALOWE

KM4S3/M 430x800x550 1 220,-

KONTENERY MOBILNE

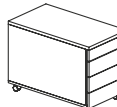
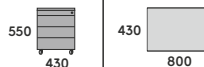

KONTENER MOBILNY
-1 SZUFLADA PŁYTOWA NISKA
Z WKŁADEM PIÓRNIKOWYM
-3 SZUFLADY PŁYTOWE

KM4S4 430x600x550 693,-

KONTENER MOBILNY
-1 SZUFLADA PIÓRNIKOWA
-3 SZUFLADY METALOWE

KM4S4/M 430x600x550 1 285,-

KONTENERY MOBILNE

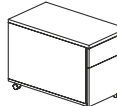
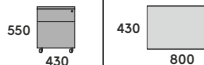

KONTENER MOBILNY
-1 SZUFLADA PŁYTOWA
-1 SZUFLADA PŁYTOWA
NA TECZKI ZAWIESZKOWE

KM4F2 430x800x550 608,-

KONTENER MOBILNY
1 SZUFLADA PŁYTOWA
1 SZUFLADA METALOWA
NA TECZKI ZAWIESZKOWE

KM4F2/M 430x800x550 1 112,-

KONTENERY MOBILNE

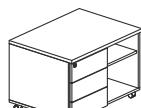
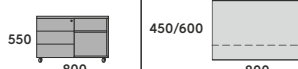

KONTENER MOBILNY
-3 SZUFLADY PŁYTOWE
-1 SZAFKA
SZUFLADY PO STRONIE:
P - PRAWEJ, L - LEWEJ

KM3S3R P/L 800x600x550 973,-
KM2S3R P/L 800x450x550 833,-

KONTENER MOBILNY
-3 SZUFLADY METALOWE
-1 SZAFKA
SZUFLADY PO STRONIE:
P - PRAWEJ, L - LEWEJ

KM3S3R/M P/L 800x600x550 1 509,-

PODUSZKA NA KONTENER MOBILNY

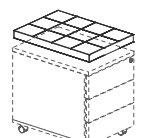
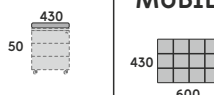

PODUSZKA NA KONTENER MOBILNY
-TYLKO DO GŁĘBOKOŚCI 600MM
-KOLORY DO WYBORU
Z PRÓBNIKA

PT 430x600x50 384,-

OPIS:

- TOP 25MM
- DÓŁ 18MM
- KORPUS 18MM
- FRONTY SZUFLAD 18MM
- ZAMEK CENTRALNY

KONTENERY STACJONARNE

KONTENERY STACJONARNE

740
430
420/600/700/800



KONTENERY STACJONARNE

740
430
420/600/700/800



KONTENERY STACJONARNE

740
430
420/600/700/800



SZUFLADY PŁYTOWE

SZUFLADY METALOWE

KONTENER STACJONARNY
-1 WKŁAD PIÓRNIKOWY
-4 SZUFLADY PŁYTOWE
-DO WYBORU UCHWYT "UB" LUB "UC"

KS4S4 UB/UC 430x800x740	866,-
KS3S4 UB/UC 430x700x740	838,-
KS2S4 UB/UC 430x600x740	795,-
KS5S4 UB/UC 430x420x740	748,-

KONTENER STACJONARNY
-1 WKŁAD PIÓRNIKOWY
-4 SZUFLADY METALOWE
-DO WYBORU UCHWYT "UB" LUB "UC"

KS4S4/M UB/UC 430x800x740	1 411,-
KS3S4/M UB/UC 430x700x740	1 387,-
KS2S4/M UB/UC 430x600x740	1 363,-

KONTENER STACJONARNY
-1 SZUFLADA PŁYTOWA NISKA Z WKŁADEM PIÓRNIKOWYM
-4 SZUFLADY PŁYTOWE
-DO WYBORU UCHWYT "UB" LUB "UC"

KS4S5 UB/UC 430x800x740	893,-
KS3S5 UB/UC 430x700x740	880,-
KS2S5 UB/UC 430x600x740	863,-
KS5S5 UB/UC 430x420x740	753,-

KONTENER STACJONARNY
-1 SZUFLADA PIÓRNIKOWA
-4 SZUFLADY METALOWE
-DO WYBORU UCHWYT "UB" LUB "UC"

KS4S5/M UB/UC 430x800x740	1 605,-
KS3S5/M UB/UC 430x700x740	1 450,-
KS2S5/M UB/UC 430x600x740	1 376,-

KONTENER STACJONARNY
-1 SZUFLADA PŁYTOWA NISKA Z WKŁADEM PIÓRNIKOWYM
-2 SZUFLADY METALOWE
-1 SZUFLADA PŁYTOWA NA TECZKI ZAWIESZKOWE
-DO WYBORU UCHWYT "UB" LUB "UC"

KS4S4F UB/UC 430x800x740	896,-
KS3S4F UB/UC 430x700x740	884,-
KS2S4F UB/UC 430x600x740	830,-
KS5S4F UB/UC 430x420x740	745,-

KONTENER STACJONARNY
-1 SZUFLADA PIÓRNIKOWA
-2 SZUFLADY METALOWE
-1 SZUFLADA METALOWA NA TECZKI ZAWIESZKOWE
-DO WYBORU UCHWYT "UB" LUB "UC"

KS4S4F/M UB/UC 430x800x740	1 508,-
KS3S4F/M UB/UC 430x700x740	1 430,-
KS2S4F/M UB/UC 430x600x740	1 373,-

W SZUFLADACH PŁYTOWYCH ZASTOSOWANO PROWADNICE ROLKOWE, WYSUW 75%.

CICHY SAMODOMYK (CD) JEST OPCJĄ.

W SZUFLADACH METALOWYCH ZASTOSOWANO PROWADNICE KULKOWE, WYSUW 80%.

CICHY SAMODOMYK (CD) JEST W STANDARDZIE.

NADSTAWKA 10H ZAMKNIĘTA

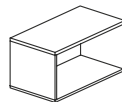
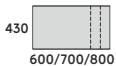
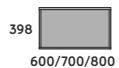

NADSTAWKA 10H NA KONTENER ZAMKNIĘTA

-PLECY PŁYTOWE 18MM

K1R1/18 600x430x398	371,-
K2R1/18 700x430x398	389,-
K3R1/18 800x430x398	408,-

NADSTAWKA 10H DRZWI PRZESUWANE

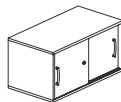
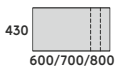
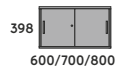

NADSTAWKA 10H NA KONTENER DRZWI PRZESUWANE

-DRZWI PRZESUWANE GR. 18MM
-DO WYBORU UCHWYT UB/UC

K1P1/18 UB/UC 600x430x398	573,-
K2P1/18 UB/UC 700x430x398	600,-
K3P1/18 UB/UC 800x430x398	628,-

NADSTAWKA 10H DRZWI ŻALUZJOWE

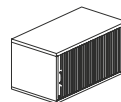
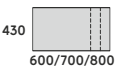

NADSTAWKA 10H NA KONTENER DRZWI ŻALUZJOWE

-DRZWI ŻALUZJOWE P/L - ŻALUZJA OTWIERANA NA PRAWĄ/LEWĄ STRONĘ

K1Z1/18 P/L UB/UC 600x430x398	933,-
K2Z1/18 P/L UB/UC 700x430x398	970,-
K3Z1/18 P/L UB/UC 800x430x398	1 010,-

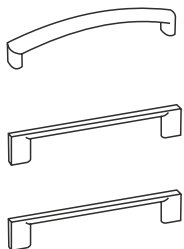

UCHWYT WLICZONY JEST TYLKO W CENĘ KONTENERÓW STACJONARNYCH I NADSTAWEK
DOMYSLNIE STOSOWANY JEST UCHWYT UD (SREBRNY)

UCHWYT SREBRNY

UD rozstaw 128 mm 27,-

UCHWYT BIAŁY

UB rozstaw 128 mm 27,-

UCHWYT CZARNY

UC rozstaw 128 mm 27,-



CICHY SAMODOMYK

CD 32,-

- CENA ZA CICHY SAMODOMYK
W JEDNEJ SZUFLADZIE

- DO KONTENERÓW
Z SZUFLADAMI PŁYTOWYMI

OPIS:

- TOP 25MM
- DÓŁ 18MM
- BOK 18MM
- PÓŁKI 18MM
- PÓŁKI RUCHOME WZDŁUŻ CAŁEGO BOKU
- TYŁ SZAFKI 3MM LUB 18MM

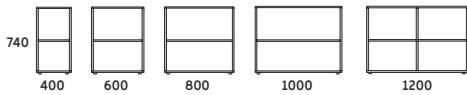
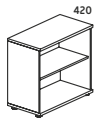

20H

TYŁ SZAFY: 3 MM HDF BIAŁY

DU2R2 400x420x740	280,-
DU5R2 600x420x740	314,-
DU1R2 800x420x740	346,-
DU4R2 1000x420x740	415,-
DU3R2 1200x420x740	429,-

TYŁ SZAFY: 18 MM MELAMINA

DU2R2/18 400x420x740	317,-
DU5R2/18 600x420x740	362,-
DU1R2/18 800x420x740	406,-
DU4R2/18 1000x420x740	472,-
DU3R2/18 1200x420x740	496,-

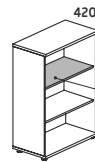

PÓŁKA STEŻAJĄCA
RUCHOMA

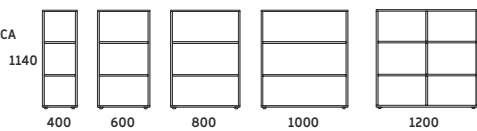

30H

TYŁ SZAFY: 3 MM HDF BIAŁY

DU2R3 400x420x1138	352,-
DU5R3 600x420x1138	407,-
DU1R3 800x420x1138	462,-
DU4R3 1000x420x1138	553,-
DU3R3 1200x420x1138	574,-

TYŁ SZAFY: 18 MM MELAMINA

DU2R3/18 400x420x1138	397,-
DU5R3/18 600x420x1138	463,-
DU1R3/18 800x420x1138	528,-
DU4R3/18 1000x420x1138	627,-
DU3R3/18 1200x420x1138	650,-

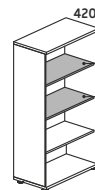

PÓŁKA STEŻAJĄCA
RUCHOMA

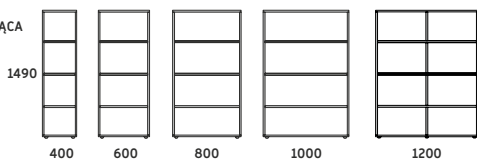

40H

TYŁ SZAFY: 3 MM HDF BIAŁY

DU2R4 400x420x1487	426,-
DU5R4 600x420x1487	498,-
DU1R4 800x420x1487	569,-
DU4R4 1000x420x1487	682,-
DU3R4 1200x420x1487	708,-

TYŁ SZAFY: 18 MM MELAMINA

DU2R4/18 400x420x1487	487,-
DU5R4/18 600x420x1487	580,-
DU1R4/18 800x420x1487	672,-
DU4R4/18 1000x420x1487	798,-
DU3R4/18 1200x420x1487	828,-

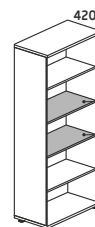

PÓŁKA STEŻAJĄCA
RUCHOMA

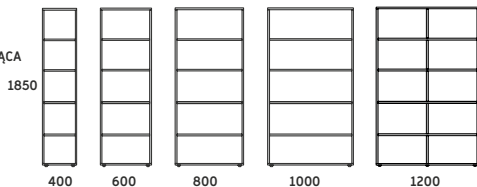

50H

TYŁ SZAFY: 3 MM HDF BIAŁY

DU2R5 400x420x1845	473,-
DU5R5 600x420x1845	550,-
DU1R5 800x420x1845	627,-
DU4R5 1000x420x1845	744,-
DU3R5 1200x420x1845	773,-

TYŁ SZAFY: 18 MM MELAMINA

DU2R5/18 400x420x1845	574,-
DU5R5/18 600x420x1845	685,-
DU1R5/18 800x420x1845	795,-
DU4R5/18 1000x420x1845	945,-
DU3R5/18 1200x420x1845	980,-

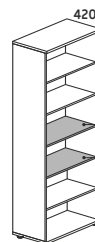

PÓŁKA STEŻAJĄCA
RUCHOMA

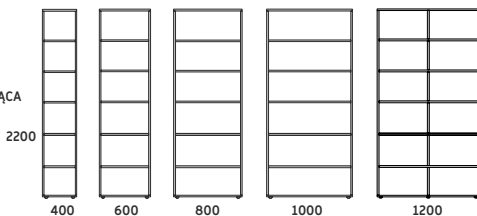

60H

TYŁ SZAFY: 3 MM HDF BIAŁY

DU2R6 400x420x2203	569,-
DU5R6 600x420x2203	658,-
DU1R6 800x420x2203	748,-
DU4R6 1000x420x2203	888,-
DU3R6 1200x420x2203	921,-

TYŁ SZAFY: 18 MM MELAMINA

DU2R6/18 400x420x2203	642,-
DU5R6/18 600x420x2203	762,-
DU1R6/18 800x420x2203	882,-
DU4R6/18 1000x420x2203	1040,-
DU3R6/18 1200x420x2203	1088,-

OPIS:

- TOP 25MM
- DÓŁ 18MM
- BOK 18MM
- TYŁ SZAFKI 3MM LUB 18MM
- PÓŁKI 18MM
- DRZWI 18MM
- PÓŁKI RUCHOME WZDŁUŻ CAŁEGO BOKU
- DOMYŚLNY KIERUNEK MONTAŻU DRZWI - PRAWY
- ZAMEK ZWYKŁY Z WYMIENNĄ WKŁADKĄ W STANDARDZIE

-DOMYŚLNY KIERUNEK MONTAŻU DRZWI - PRAWY

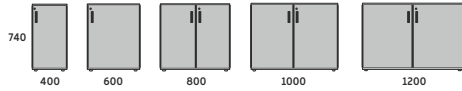
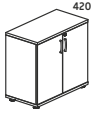

20H

TYŁ SZAFY: 3 MM
HDF BIAŁY

DU2D2 P/L	400x420x740	389,-
DU5D2 P/L	600x420x740	475,-
DU1D2	800x420x740	551,-
DU4D2	1000x420x740	637,-
DU3D2	1200x420x740	682,-

TYŁ SZAFY: 18 MM
MELAMINA

DU2D2/18 P/L	400x420x740	430,-
DU5D2/18 P/L	600x420x740	520,-
DU1D2/18	800x420x740	605,-
DU4D2/18	1000x420x740	724,-
DU3D2/18	1200x420x740	758,-

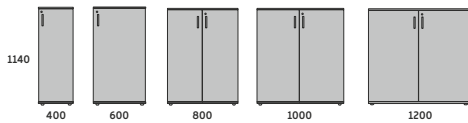
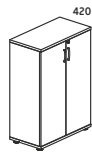

30H

TYŁ SZAFY: 3 MM
HDF BIAŁY

DU2D3 P/L	400x420x1138	497,-
DU5D3 P/L	600x420x1138	600,-
DU1D3	800x420x1138	682,-
DU4D3	1000x420x1138	820,-
DU3D3	1200x420x1138	855,-

TYŁ SZAFY: 18 MM
MELAMINA

DU2D3/18 P/L	400x420x1138	552,-
DU5D3/18 P/L	600x420x1138	660,-
DU1D3/18	800x420x1138	763,-
DU4D3/18	1000x420x1138	914,-
DU3D3/18	1200x420x1138	956,-

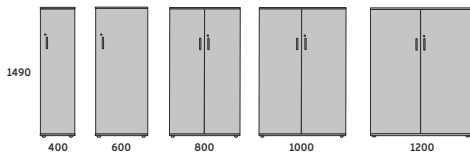
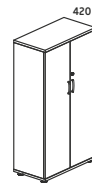

40H

TYŁ SZAFY: 3 MM
HDF BIAŁY

DU2D4 P/L	400x420x1487	611,-
DU5D4 P/L	600x420x1487	726,-
DU1D4	800x420x1487	841,-
DU4D4	1000x420x1487	1 008,-
DU3D4	1200x420x1487	1 052,-

TYŁ SZAFY: 18 MM
MELAMINA

DU2D4/18 P/L	400x420x1487	666,-
DU5D4/18 P/L	600x420x1487	822,-
DU1D4/18	800x420x1487	977,-
DU4D4/18	1000x420x1487	1 175,-
DU3D4/18	1200x420x1487	1 225,-

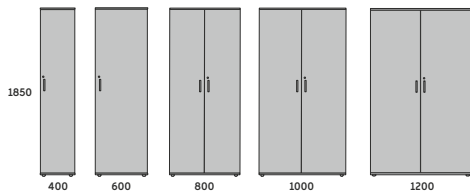
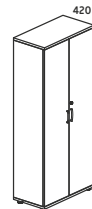

50H

TYŁ SZAFY: 3 MM
HDF BIAŁY

DU2D5 P/L	400x420x1845	679,-
DU5D5 P/L	600x420x1845	821,-
DU1D5	800x420x1845	962,-
DU4D5	1000x420x1845	1 163,-
DU3D5	1200x420x1845	1 206,-

TYŁ SZAFY: 18 MM
MELAMINA

DU2D5/18 P/L	400x420x1845	759,-
DU5D5/18 P/L	600x420x1845	926,-
DU1D5/18	800x420x1845	1 093,-
DU4D5/18	1000x420x1845	1 224,-
DU3D5/18	1200x420x1845	1 320,-

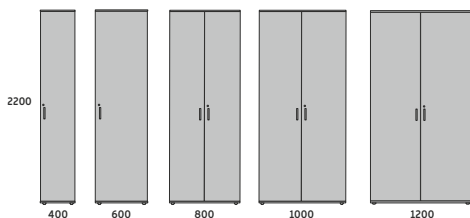
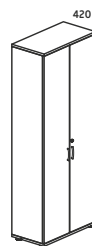

60H

TYŁ SZAFY: 3 MM
HDF BIAŁY

DU2D6 P/L	400x420x2203	758,-
DU5D6 P/L	600x420x2203	925,-
DU1D6	800x420x2203	1 092,-
DU4D6	1000x420x2203	1 308,-
DU3D6	1200x420x2203	1 358,-

TYŁ SZAFY: 18 MM
MELAMINA

DU2D6/18 P/L	400x420x2203	856,-
DU5D6/18 P/L	600x420x2203	1 076,-
DU1D6/18	800x420x2203	1 296,-
DU4D6/18	1000x420x2203	1 588,-
DU3D6/18	1200x420x2203	1 612,-

OPIS:

- TOP 25MM
- DÓŁ 18MM
- BOK 18MM
- TYŁ SZAFKI 3MM LUB 18MM
- PÓŁKI 18MM
- PÓŁKI RUCHOME
- DRZWI 18MM
- ZAMEK ZWYKŁY Z WYMIENNĄ WKŁADKĄ W STANDARDZIE

-DOMYŚLNY KIERUNEK MONTAŻU DRZWI - PRAWY

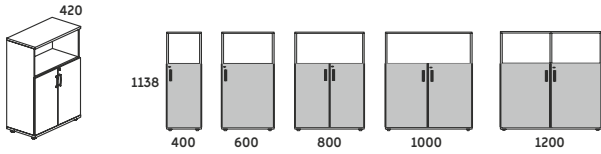

30H

TYŁ SZAFY: 3 MM
HDF BIAŁY

DU2D2/R1 P/L 400x420x1138	467,-
DU5D2/R1 P/L 600x420x1138	570,-
DU1D2/R1 800x420x1138	670,-
DU4D2/R1 1000x420x1138	805,-
DU3D2/R1 1200x420x1138	840,-

TYŁ SZAFY: 18 MM
MELAMINA

DU2D2/R1/18 P/L 400x420x1138	521,-
DU5D2/R1/18 P/L 600x420x1138	626,-
DU1D2/R1/18 800x420x1138	731,-
DU4D2/R1/18 1000x420x1138	878,-
DU3D2/R1/18 1200x420x1138	908,-

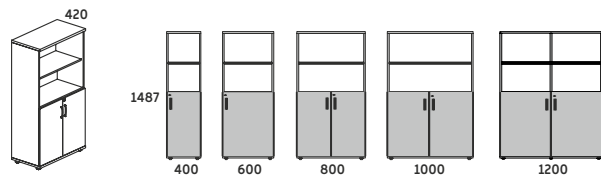

40H

TYŁ SZAFY: 3 MM
HDF BIAŁY

DU2D2/R2 P/L 400x420x1487	561,-
DU5D2/R2 P/L 600x420x1487	665,-
DU1D2/R2 800x420x1487	770,-
DU4D2/R2 1000x420x1487	924,-
DU3D2/R2 1200x420x1487	957,-

TYŁ SZAFY: 18 MM
MELAMINA

DU2D2/R2/18 P/L 400x420x1487	644,-
DU5D2/R2/18 P/L 600x420x1487	755,-
DU1D2/R2/18 800x420x1487	866,-
DU4D2/R2/18 1000x420x1487	1 039,-
DU3D2/R2/18 1200x420x1487	1 078,-

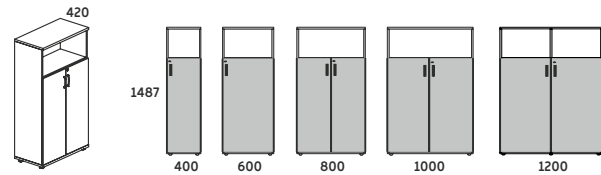

40H

TYŁ SZAFY: 3 MM
HDF BIAŁY

DU2D3/R1 P/L 400x420x1487	593,-
DU5D3/R1 P/L 600x420x1487	705,-
DU1D3/R1 800x420x1487	816,-
DU4D3/R1 1000x420x1487	978,-
DU3D3/R1 1200x420x1487	1 014,-

TYŁ SZAFY: 18 MM
MELAMINA

DU2D3/R1/18 P/L 400x420x1487	651,-
DU5D3/R1/18 P/L 600x420x1487	789,-
DU1D3/R1/18 800x420x1487	926,-
DU4D3/R1/18 1000x420x1487	1 109,-
DU3D3/R1/18 1200x420x1487	1 151,-

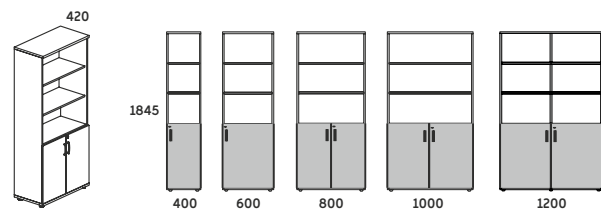

50H

TYŁ SZAFY: 3 MM
HDF BIAŁY

DU2D2/R3 P/L 400x420x1845	604,-
DU5D2/R3 P/L 600x420x1845	726,-
DU1D2/R3 800x420x1845	847,-
DU4D2/R3 1000x420x1845	1 015,-
DU3D2/R3 1200x420x1845	1 063,-

TYŁ SZAFY: 18 MM
MELAMINA

DU2D2/R3/18 P/L 400x420x1845	689,-
DU5D2/R3/18 P/L 600x420x1845	840,-
DU1D2/R3/18 800x420x1845	992,-
DU4D2/R3/18 1000x420x1845	1 189,-
DU3D2/R3/18 1200x420x1845	1 239,-



50H

TYŁ SZAFY: 3 MM
HDF BIAŁY

DU2D3/R2 P/L 400x420x1845	621,-
DU5D3/R2 P/L 600x420x1845	754,-
DU1D3/R2 800x420x1845	886,-
DU4D3/R2 1000x420x1845	1 061,-
DU3D3/R2 1200x420x1845	1 102,-

TYŁ SZAFY: 18 MM MELAMINA

DU2D3/R2/18 P/L 400x420x1845	706,-
DU5D3/R2/18 P/L 600x420x1845	870,-
DU1D3/R2/18 800x420x1845	1 029,-
DU4D3/R2/18 1000x420x1845	1 232,-
DU3D3/R2/18 1200x420x1845	1 280,-

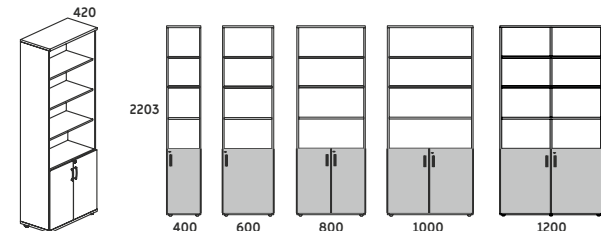

60H

TYŁ SZAFY: 3 MM
HDF BIAŁY

DU2D2/R4 P/L 400x420x2203	681,-
DU5D2/R4 P/L 600x420x2203	806,-
DU1D2/R4 800x420x2203	932,-
DU4D2/R4 1000x420x2203	1 107,-
DU3D2/R4 1200x420x2203	1 159,-

TYŁ SZAFY: 18 MM MELAMINA

DU2D2/R4/18 P/L 400x420x2203	761,-
DU5D2/R4/18 P/L 600x420x2203	930,-
DU1D2/R4/18 800x420x2203	1 093,-
DU4D2/R4/18 1000x420x2203	1 233,-
DU3D2/R4/18 1200x420x2203	1 280,-

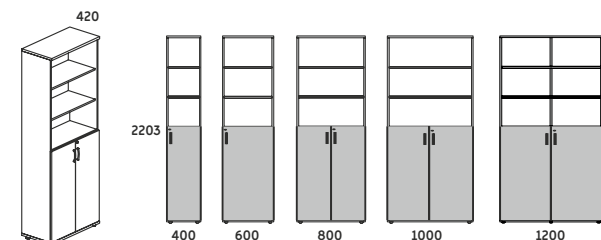

60H

TYŁ SZAFY: 3 MM
HDF BIAŁY

DU2D3/R3 P/L 400x420x2203	703,-
DU5D3/R3 P/L 600x420x2203	838,-
DU1D3/R3 800x420x2203	973,-
DU4D3/R3 1000x420x2203	1 170,-
DU3D3/R3 1200x420x2203	1 210,-

TYŁ SZAFY: 18 MM MELAMINA

DU2D3/R3/18 P/L 400x420x2203	782,-
DU5D3/R3/18 P/L 600x420x2203	962,-
DU1D3/R3/18 800x420x2203	1 142,-
DU4D3/R3/18 1000x420x2203	1 357,-
DU3D3/R3/18 1200x420x2203	1 420,-

SZAFY UBRANIOWE

OPIS:

- TOP 25MM
- DÓŁ 18MM
- BOK 18MM
- PÓŁKI 18MM
- DRZWI 18MM
- TYŁ SZAFY 3MM LUB 18MM
- WIESZAK WYSUWANY
- DRAŻEK UBRANIOWY

-DOMYŚLNY KIERUNEK MONTAŻU DRZWI - PRAWY

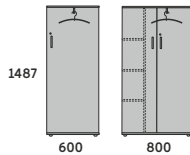
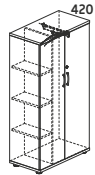

WIESZAK WYSUWANY
40H

TYŁ SZAFY: 3 MM
HDF BIAŁY

TYŁ SZAFY: 18 MM
MELAMINA

DU5U4W P/L 600x420x1487	770,-
DU1U4W 800x420x1487	955,-

DU5U4W/18 P/L 600x420x1487	810,-
DU1U4W/18 800x420x1487	1 020,-

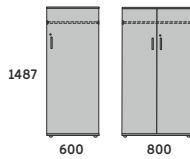
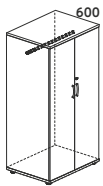

DRAŻEK UBRANIOWY
40H

TYŁ SZAFY: 3 MM
HDF BIAŁY

TYŁ SZAFY: 18 MM
MELAMINA

DU5U4S P/L 600x600x1487	780,-
DU1U4S 800x600x1487	820,-

DU5U4S/18 P/L 600x600x1487	845,-
DU1U4S/18 800x600x1487	1 065,-

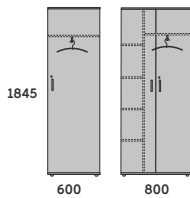
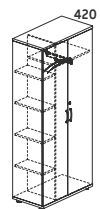

WIESZAK WYSUWANY
50H

TYŁ SZAFY: 3 MM
HDF BIAŁY

TYŁ SZAFY: 18 MM MELAMINA

DU5U5W P/L 600x420x1845	722,-
DU1U5W 800x420x1845	1 016,-

DU5U5W/18 P/L 600x420x1845	828,-
DU1U5W/18 800x420x1845	1 156,-

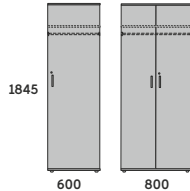
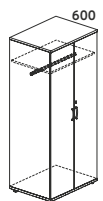

DRAŻEK UBRANIOWY
50H

TYŁ SZAFY: 3 MM
HDF BIAŁY

TYŁ SZAFY: 18 MM
MELAMINA

DU5U5S P/L 600x600x1845	826,-
DU1U5S 800x600x1845	1 024,-

DU5U5S/18 P/L 600x600x1845	929,-
DU1U5S/18 800x600x1845	1 145,-

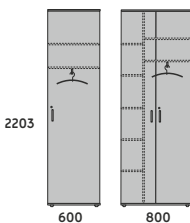
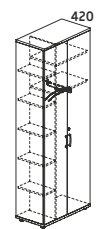

WIESZAK WYSUWANY
60H

TYŁ SZAFY: 3 MM
HDF BIAŁY

TYŁ SZAFY: 18 MM MELAMINA

DU5U6W P/L 600x420x2203	1 042,-
DU1U6W 800x420x2203	1 158,-

DU5U6W/18 P/L 600x420x2203	1 190,-
DU1U6W/18 800x420x2203	1 322,-

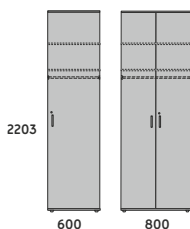
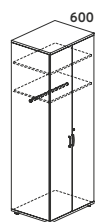

DRAŻEK UBRANIOWY
60H

TYŁ SZAFY: 3 MM
HDF BIAŁY

TYŁ SZAFY: 18 MM
MELAMINA

DU5U6S P/L 600x600x2203	1 042,-
DU1U6S 800x600x2203	1 157,-

DU5U6S/18 P/L 600x600x2203	1 180,-
DU1U6S/18 800x600x2203	1 308,-

SZAFY DRZWI PRZESUWANE

OPIS:

- TOP 25MM
- DÓŁ 18MM
- BOK 18MM
- TYŁ 18MM
- PÓŁKI 18MM
- DRZWI 18MM

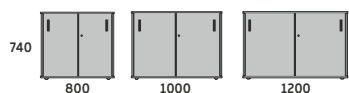
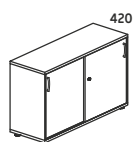

20H

TYŁ SZAFY: 18 MM
MELAMINA

DU1P2/18 800x420x740	793,-
DU4P2/18 1000x420x740	950,-
DU3P2/18 1200x420x740	1 017,-

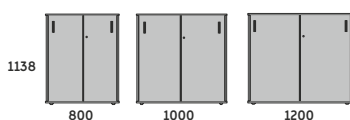

30H

TYŁ SZAFY: 18 MM
MELAMINA

DU1P3/18 800x420x1138	995,-
DU4P3/18 1000x420x1138	1 130,-
DU3P3/18 1200x420x1138	1 239,-

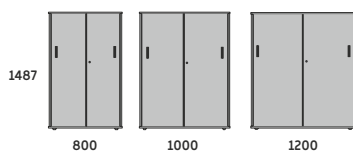
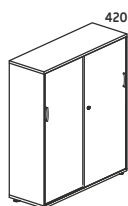

40H

TYŁ SZAFY: 18 MM
MELAMINA

DU1P4/18 800x420x1487	1 418,-
DU4P4/18 1000x420x1487	1 440,-
DU3P4/18 1200x420x1487	1 469,-

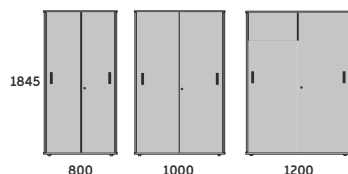
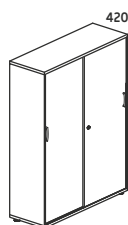

50H

TYŁ SZAFY: 18 MM
MELAMINA

DU1P5/18 800x420x1845	1 556,-
DU4P5/18 1000x420x1845	1 640,-
DU3P5/18 1200x420x1845	1 703,-

OPIS:

- TOP 25MM
- DÓŁ 18MM
- BOK 18MM
- PÓŁKI 18MM
- TYŁ SZAFKI 18MM
- ŻALUZJA Z TWORZYWA PCV
- KOLOR SREBRNY

-DOMYŚLNY KIERUNEK MONTAŻU DRZWI - PRAWY

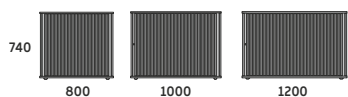
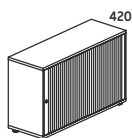

20H

TYŁ SZAFY: 18 MM
MELAMINA

DU1Z2/18 P/L 800x420x740 1 346,-
DU4Z2/18 P/L 1000x420x740 1 580,-
DU3Z2/18 P/L 1200x420x740 1 808,-

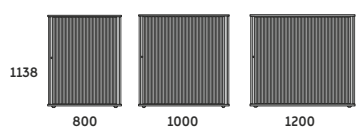
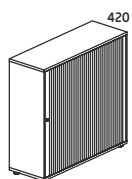

30H

TYŁ SZAFY: 18 MM
MELAMINA

DU1Z3/18 P/L 800x420x1138 1 740,-
DU4Z3/18 P/L 1000x420x1138 2 080,-
DU3Z3/18 P/L 1200x420x1138 2 409,-

SZAFY KARTOTEKOWE

OPIS:

- TOP 25MM
- DÓŁ 18MM
- BOK 18MM
- TYŁ 18MM
- FRONT SZUFLADY 18MM
- METABOXY Z DNEM
- PRĘTY DO WIESZANIA TECZEK
- BLOKADA WYSUWU SZUFLADY
- ZAMEK CENTRALNY

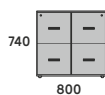

20H

SZAFY KARTOTEKOWE

DU2S4/18 800x420x740 1 183,-

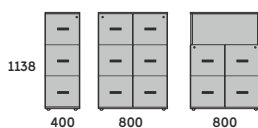

30H

SZAFY KARTOTEKOWE

DU2S3/18 400x420x1138 926,-
DU1S6/18 800x420x1138 1 596,-
DU1S4/R1/18 800x420x1138 1 280,-

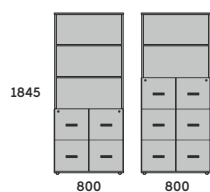
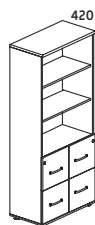

50H

SZAFY KARTOTEKOWE

DU1S4/R3/18 800x420x1845 1 410,-
DU1S6/R2/18 800x420x1845 1 810,-

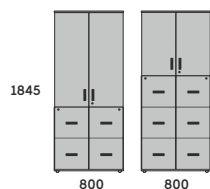
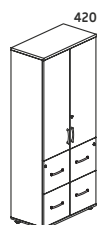

50H

SZAFY KARTOTEKOWE

DU1S4/D3/18 800x420x1845 1 846,-
DU1S6/D2/18 800x420x1845 2 100,-

OPIS:

- TOP 25MM
- DÓŁ 18MM
- BOK 18MM
- TYŁ SZAFKI ZAWSZE 18MM



ZAMEK ZWYKŁY (Z)



ZAMEK SZFROWY
MANUALNY (S)



ZAMEK SZFROWY
ELEKTRONICZNY (P)



ZAMEK NA KARTĘ (E)

-DOMYŚLNY KIERUNEK MONTAŻU DRZWI - PRAWY

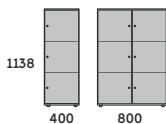
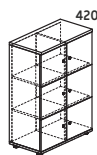

30H

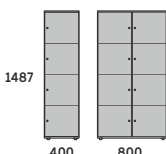
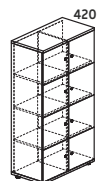

40H

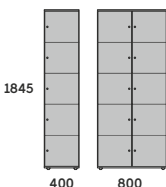
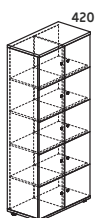

50H

SZAFY CODE

BEZ WRZUTNI

CD2SK3/Z P/L 400x420x1138	816,-
CD1SK3/Z 800x420x1138	1 404,-
CD2SK3/S P/L 400x420x1138	1 123,-
CD1SK3/S 800x420x1138	1 924,-
CD2SK3/P P/L 400x420x1138	2 234,-
CD1SK3/P 800x420x1138	4 022,-
CD2SK3/E P/L 400x420x1138	2 234,-
CD1SK3/E 800x420x1138	4 022,-

SZAFY CODE

BEZ WRZUTNI

CD2SK4/Z P/L 400x420x1487	997,-
CD1SK4/Z 800x420x1487	1 664,-
CD2SK4/S P/L 400x420x1487	1 358,-
CD1SK4/S 800x420x1487	2 433,-
CD2SK4/P P/L 400x420x1487	2 765,-
CD1SK4/P 800x420x1487	5 040,-
CD2SK4/E P/L 400x420x1487	2 765,-
CD1SK4/E 800x420x1487	5 040,-

SZAFY CODE

BEZ WRZUTNI

CD2SK5/Z P/L 400x420x1845	1 213,-
CD1SK5/Z 800x420x1845	2 050,-
CD2SK5/S P/L 400x420x1845	1 640,-
CD1SK5/S 800x420x1845	2 762,-
CD2SK5/P P/L 400x420x1845	3 358,-
CD1SK5/P 800x420x1845	6 128,-
CD2SK5/E P/L 400x420x1845	3 358,-
CD1SK5/E 800x420x1845	6 128,-

SZAFY CODE Z WRZUTNIĄ

SZAFY CODE

Z WRZUTNIĄ 20MM I DODATKOWĄ PÓŁKĄ

CD2SK3W/Z P/L 400x420x1138	883,-
CD1SK3W/Z 800x420x1138	1 534,-
CD2SK3W/S P/L 400x420x1138	1 189,-
CD1SK3W/S 800x420x1138	2 054,-
CD2SK3W/P P/L 400x420x1138	2 304,-
CD1SK3W/P 800x420x1138	4 152,-
CD2SK3W/E P/L 400x420x1138	2 304,-
CD1SK3W/E 800x420x1138	4 152,-

SZAFY CODE

Z WRZUTNIĄ 20MM I DODATKOWĄ PÓŁKĄ

CD2SK3W/Z P/L 400x420x1490	1 087,-
CD1SK3W/Z 800x420x1490	1 834,-
CD2SK3W/S P/L 400x420x1490	1 528,-
CD1SK3W/S 800x420x1490	2 603,-
CD2SK3W/P P/L 400x420x1490	2 855,-
CD1SK3W/P 800x420x1490	5 210,-
CD2SK3W/E P/L 400x420x1490	2 855,-
CD1SK3W/E 800x420x1490	5 210,-

SZAFY CODE

Z WRZUTNIĄ 20MM I DODATKOWĄ PÓŁKĄ

CD2SK3W/Z P/L 400x420x1850	1 328,-
CD1SK3W/Z 800x420x1850	2 270,-
CD2SK3W/S P/L 400x420x1850	1 755,-
CD1SK3W/S 800x420x1850	2 982,-
CD2SK3W/P P/L 400x420x1850	3 473,-
CD1SK3W/P 800x420x1850	6 348,-
CD2SK3W/E P/L 400x420x1850	3 473,-
CD1SK3W/E 800x420x1850	6 348,-

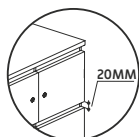

-DOMYŚLNY KIERUNEK MONTAŻU DRZWI - PRAWY

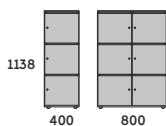
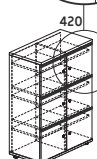

30H

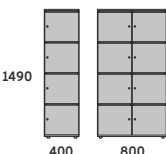
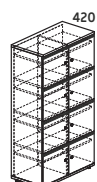

40H

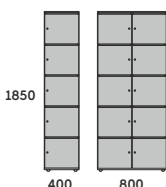
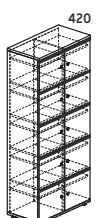

50H

OPIS:

- TOP 25MM
- DÓŁ 25MM
- BOK 18MM
- PÓŁKI 18MM
- PÓŁKI RUCHOME 3 POZIOMY REGULACJI
- TYŁ SZAFKI 3MM LUB 18MM

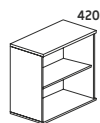

-DOMYŚLNY KIERUNEK MONTAŻU DRZWI - PRAWY

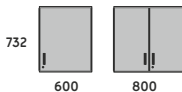
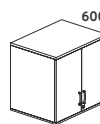
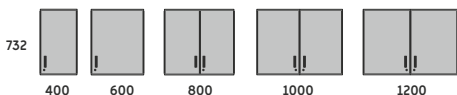
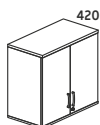
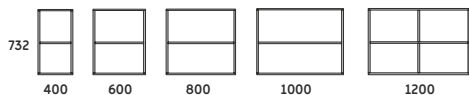

TYŁ SZAFY: 3 MM HDF BIAŁY

DUN2R2	400x420x732	279,-
DUN5R2	600x420x732	325,-
DUN1R2	800x420x732	358,-
DUN4R2	1000x420x732	430,-
DUN3R2	1200x420x732	448,-

TYŁ SZAFY: 18 MM MELAMINA

DUN2R2/18	400x420x732	309,-
DUN5R2/18	600x420x732	357,-
DUN1R2/18	800x420x732	399,-
DUN4R2/18	1000x420x732	477,-
DUN3R2/18	1200x420x732	500,-

TYŁ SZAFY: 3 MM HDF BIAŁY

DUN2D2 P/L	400x420x732	388,-
DUN5D2 P/L	600x420x732	470,-
DUN1D2	800x420x732	536,-
DUN4D2	1000x420x732	659,-
DUN3D2	1200x420x732	700,-

TYŁ SZAFY: 18 MM MELAMINA

DUN2D2/18 P/L	400x420x732	430,-
DUN5D2/18 P/L	600x420x732	525,-
DUN1D2/18	800x420x732	602,-
DUN4D2/18	1000x420x732	712,-
DUN3D2/18	1200x420x732	776,-

TYŁ SZAFY: 3 MM HDF BIAŁY

DUN5D2/600 P/L	600x600x732	504,-
DUN1D2/600	800x600x732	634,-

TYŁ SZAFY: 18 MM MELAMINA

DUN5D2/600/18 P/L	600x600x732	543,-
DUN1D2/600/18	800x600x732	691,-

DRZWI SZKLANE 3OH



SZKŁO PRZEZROCZYSTE

DRZWI SZKLANE BEZRAMKOWE 3OH

DU1S3	800x20x1100	922,-
-------	-------------	-------



SZKŁO SATYNOWE

DRZWI SZKLANE W RAMCE ALUMINIOWEJ 3OH

TPS3	800x20x1100	940,-
------	-------------	-------

ZAMEK BASKWIŁOWY



ZAMEK BASKWIŁOWY KOMPLET

ZMB - CENA JEDNAKOWA DLA KAŻDEJ WYSOKOŚCI	123,-
--	-------

CICHY DOMEK DO ZAWIASÓW



IŁOŚĆ ZAWIASÓW W SZAFACH:

	1 - DRZWIOWYCH	2 - DRZWIOWYCH
2+3 OH	2	4
4+5 OH	3	6
5 OH ubraniowa	4	8
6 OH	4	8

CICHY DOMEK DO ZAWIASÓW

ZCD 100x65x25	9,-
---------------	-----

UCHWYTY 128MM



UCHWYT SREBRNY

UD rozstaw 128 mm



UCHWYT BIAŁY

UB rozstaw 128 mm



UCHWYT CZARNY

UC rozstaw 128 mm

DOMYŚLNIE STOSOWANY JEST UCHWYT UD (SREBRNY)

WYMIANA NA UCHWYT UB LUB UC - OPCJA BEZPŁATNA

OPIS:

-STELAŻ Ø40 MM

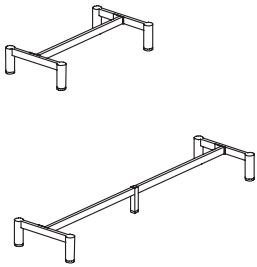

**STELAŻ 400, 600, 800, 1000
DO SZAF DUO-C**

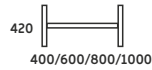

400/600/800/1000

**STELAŻ 1200, 1600
DO SZAF DUO-C**



1200/1600

STELAŻ 1600 SŁUŻY DO POSTAWIENIA
DWÓCH SZAF O SZEROKOŚCI 800 MM

STELAŻ DUO-C

CSC400	400x420x150	360,-
CSC600	600x420x150	380,-
CSC800	800x420x150	410,-
CSC1000	1000x420x150	441,-

STELAŻ DUO-C

CSC1200	1200x420x150	452,-
CSC1600	1600x420x150	473,-

OPIS:

-STELAŻ 40X40 MM

PODSTAWA STELAŻ DUO-U

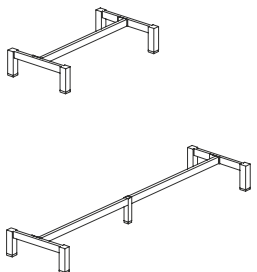

**STELAŻ 400, 600, 800, 1000
DO SZAF DUO-U**



400/600/800/1000

**STELAŻ 1200, 1600
DO SZAF DUO-U**



1200/1600

STELAŻ 1600 SŁUŻY DO POSTAWIENIA
DWÓCH SZAF O SZEROKOŚCI 800 MM

STELAŻ DUO-U

USC400	400x420x150	370,-
USC600	600x420x150	405,-
USC800	800x420x150	438,-
USC1000	1000x420x150	460,-

STELAŻ DUO-U

USC1200	1200x420x150	482,-
USC1600	1600x420x150	519,-

OPIS:

-STELAŻ 50X25 MM

PODSTAWA STELAŻ DUO-A

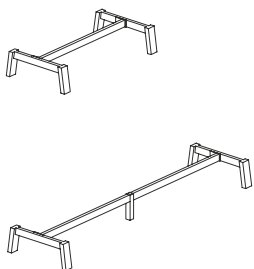

**STELAŻ 400, 600, 800, 1000
DO SZAF DUO-A**



400/600/800/1000

**STELAŻ 1200, 1600
DO SZAF DUO-A**



1200/1600

STELAŻ 1600 SŁUŻY DO POSTAWIENIA
DWÓCH SZAF O SZEROKOŚCI 800 MM

STELAŻ DUO-A

ASC400	400x420x150	375,-
ASC600	600x420x150	440,-
ASC800	800x420x150	464,-
ASC1000	1000x420x150	475,-

STELAŻ DUO-A

ASC1200	1200x420x150	500,-
ASC1600	1600x420x150	512,-

OPIS:

-STELAŻ 50X25 MM

PODSTAWA STELAŻ DUO-O

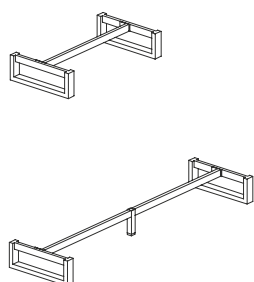

**STELAŻ 400, 600, 800, 1000
DO SZAF DUO-O**



400/600/800/1000

**STELAŻ 1200, 1600
DO SZAF DUO-O**



1200/1600

STELAŻ 1600 SŁUŻY DO POSTAWIENIA
DWÓCH SZAF O SZEROKOŚCI 800 MM

STELAŻ DUO-O

OSC400	400x420x150	390,-
OSC600	600x420x150	420,-
OSC800	800x420x150	486,-
OSC1000	1000x420x150	495,-

STELAŻ DUO-O

OSC1200	1200x420x150	500,-
OSC1600	1600x420x150	519,-

OPIS:
-STELAŻ 50X25 MM

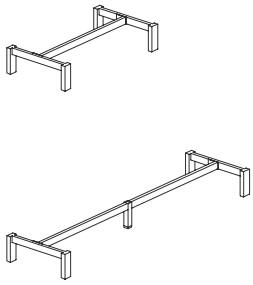

STELAŻ 400, 600, 800, 1000 DO SZAF DUO-N

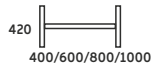

STELAŻ 1200, 1600 DO SZAF DUO-N

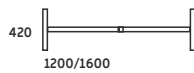

STELAŻ 1600 SŁUŻY DO POSTAWIENIA
DWÓCH SZAF O SZEROKOŚCI 800 MM

STELAŻ DUO-N

NSC400 400x420x150	365,-
NSC600 600x420x150	400,-
NSC800 800x420x150	430,-
NSC1000 1000x420x150	450,-

STELAŻ DUO-N

NSC1200 1200x420x150	475,-
NSC1600 1600x420x150	509,-

COKOŁY METALOWE 30MM

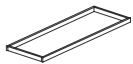

COKÓŁ DO SZAF DUO

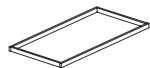
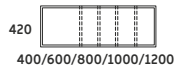

COKÓŁ DO SZAF DUO

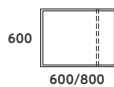

COKOŁY METALOWE

CM02 400x420x30	206,-
CM05 600x420x30	228,-
CM01 800x420x30	252,-
CM04 1000x420x30	268,-
CM03 1200x420x30	293,-

COKOŁY METALOWE SZAFY UBRANIOWE

CM65 600x600x30	234,-
CM61 800x600x30	254,-

OPIS:
- KORPUS KWIETNIKA
PŁYTA 18MM

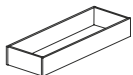

KWIETNIKI - SZAFY DUO

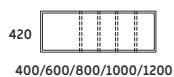

KWIETNIKI

KWIETNIKI

KW01 400x420x250	233,-
KW02 600x420x250	245,-
KW03 800x420x250	260,-
KW04 1000x420x250	286,-
KW05 1200x420x250	314,-

SZAFKA POD KSERO

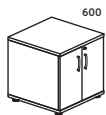

SZAFKA KSERO



SZAFKA KSERO

DU1D2X/18 600x600x600	648,-
-----------------------	-------

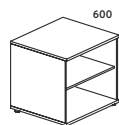

REGAŁ KSERO



REGAŁ KSERO

DU1R2X/18 600x600x600	525,-
-----------------------	-------

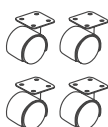

KÓŁKA MEBLOWE

KÓŁKA ZESTAW

KMX4 Ø40x50	164,-
-------------	-------

Schemat rozmieszczenia przelotek i mediaboxów w DUO

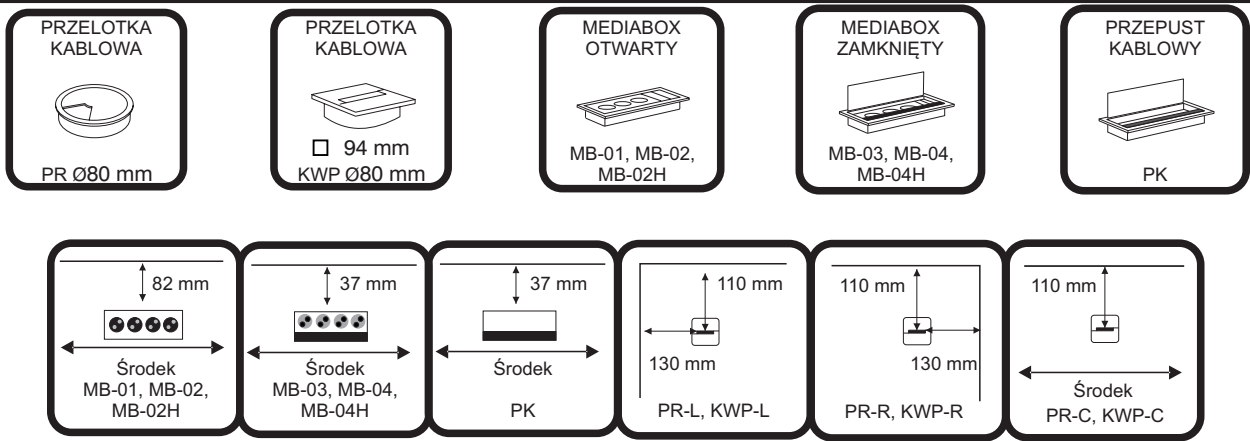

BIURKA PROSTE PRZYKŁAD ZAMÓWIENIA: CD-P01/PK

Sposoby umieszczenia oraz oznaczenia w biurkach prostych



LEWA STRONA (1 SZT.)	PR-L KWP-L
PRAWA STRONA (1 SZT.)	PR-P KWP-P
ŚRODEK (1 SZT.)	PR-C KWP-C
DWIE PRZELOTKI (PO 1 SZT. Z PRAWEJ/LEWEJ STR.)	PR-2 KWP-2

BIURKA NAROŻNE PRZYKŁAD ZAMÓWIENIA: UD-N11/PR-L

Sposoby umieszczenia oraz oznaczenia w biurkach narożnych

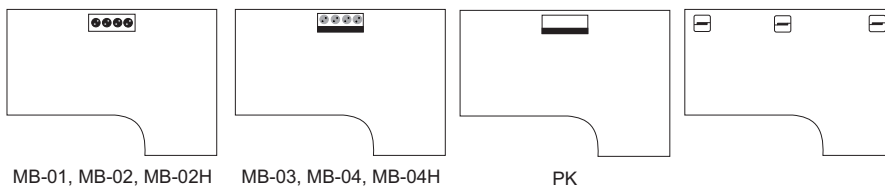

LEWA STRONA (1 SZT.)	PR-L KWP-L
PRAWA STRONA (1 SZT.)	PR-P KWP-P
ŚRODEK (1 SZT.)	PR-C KWP-C
DWIE PRZELOTKI (PO 1 SZT. Z PRAWEJ/LEWEJ STR.)	PR-2 KWP-2

BIURKA BENCH PRZYKŁAD ZAMÓWIENIA: UD-BE03/2xMB-04

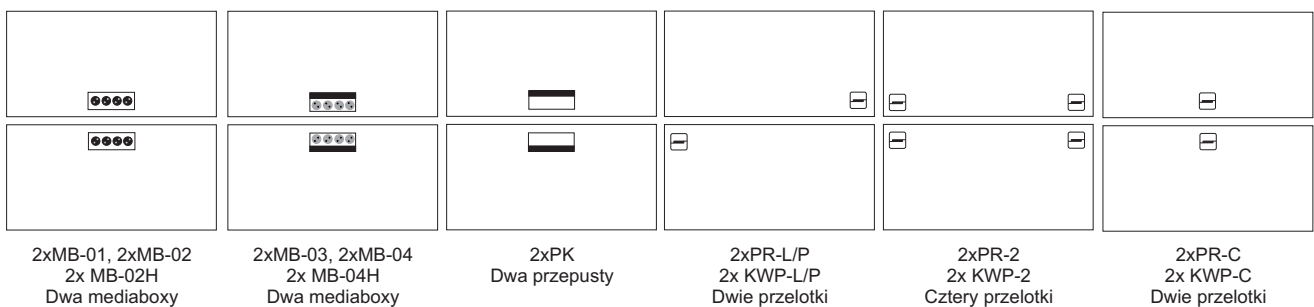

2xMB-01, 2xMB-02, 2xMB-02H Dwa mediaboxy
 2xMB-03, 2xMB-04, 2xMB-04H Dwa mediaboxy
 2xPK Dwa przepusty
 2xPR-L/P, 2xKWP-L/P Dwie przelotki
 2xPR-2, 2xKWP-2 Cztery przelotki
 2xPR-C, 2xKWP-C Dwie przelotki

STOŁY KONFERENCYJNE PRZYKŁAD ZAMÓWIENIA: UD-SKB01/MB-04

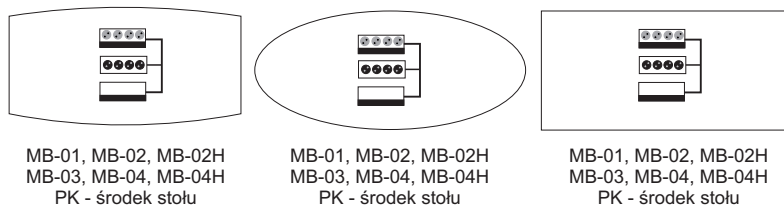

MB-01, MB-02, MB-02H
 MB-03, MB-04, MB-04H
 PK - środek stołu

MB-01, MB-02, MB-02H
 MB-03, MB-04, MB-04H
 PK - środek stołu

MB-01, MB-02, MB-02H
 MB-03, MB-04, MB-04H
 PK - środek stołu

UWAGA:
 DO SYMBOLU BIURKA DODAC
 SYMBOL PRZELOTKI
 LUB MEDIABOXU

Schemat usłojenia mebli z dekiem drewna w DUO

BIURKA PROSTE, NAROŻNE, BENCH, BIURKO Z SZAFKĄ

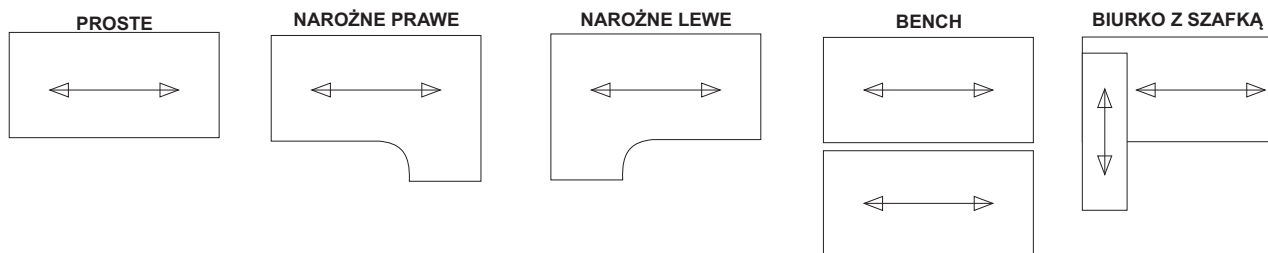

DOSTAWKI DO BIUREK

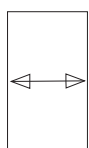

PANELE FRONTOWE, PRZEGRODY

PANEL PŁYTOWY

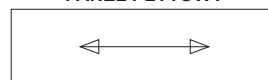

PRZEGRODA PŁYTOWA

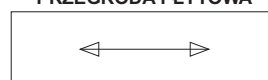

STOŁY

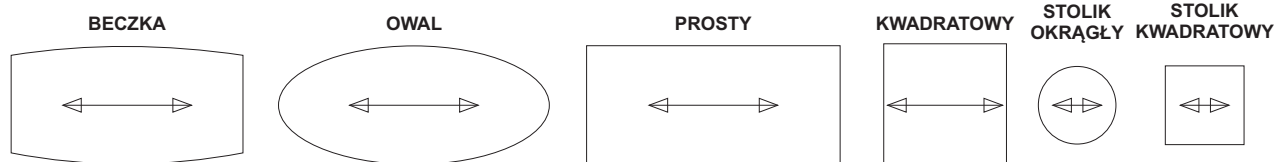

SZAFY REGAŁY

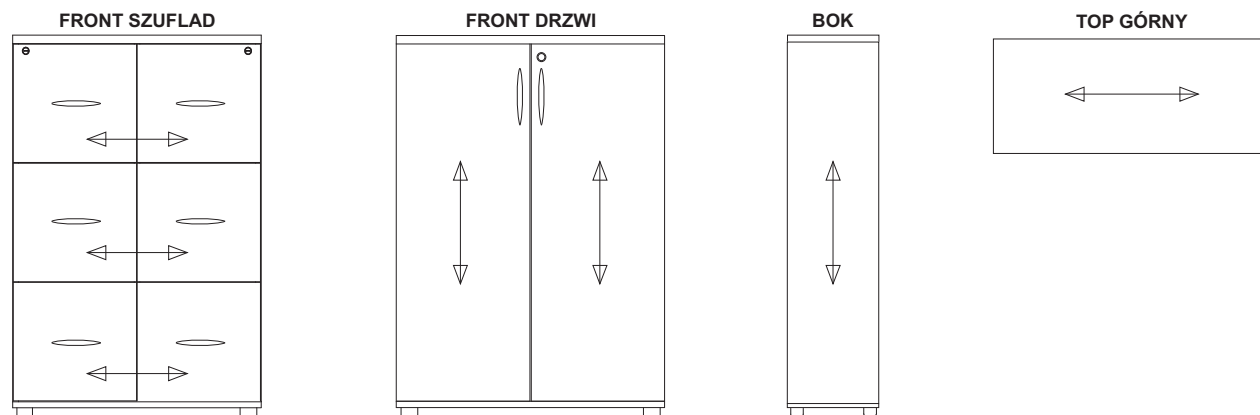

KONTENERY MOBILNE I STACJONARNE

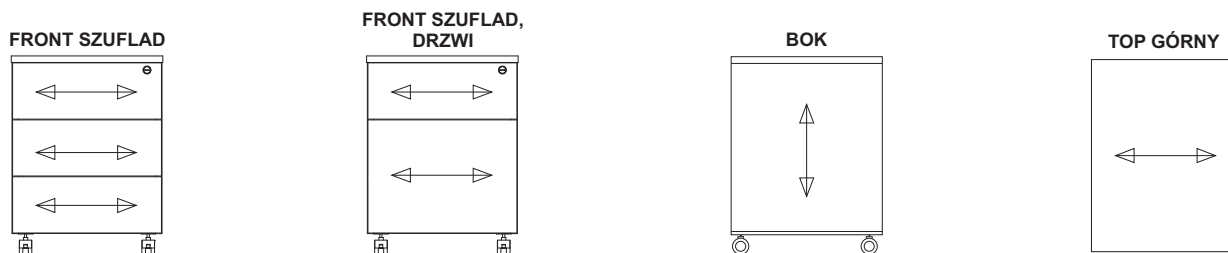

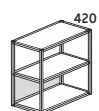

20H

20H

LF2R22 420x420x760 1 298,-
LF1R22 800x420x760 1 449,-

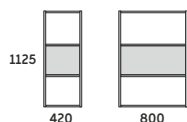
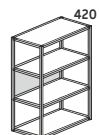

30H

30H

LF2R32 420x420x1125 1 426,-
LF1R32 800x420x1125 1 542,-

REGAŁ 20H, 30H
1x PLECY PŁYTOWE W STANDARDZIE
MONTOWANE W DOWOLNYM MIEJSCU
I Z DOWOLNEJ STRONY

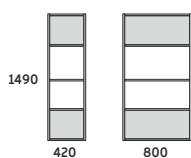
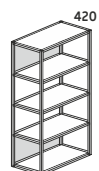

40H

40H

LF2R42 420x420x1490 1 550,-
LF1R42 800x420x1490 1 720,-

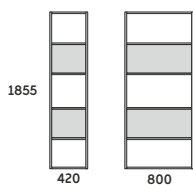
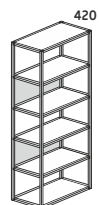

50H

50H

LF2R52 420x420x1855 1 640,-
LF1R52 800x420x1855 1 870,-

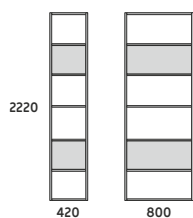
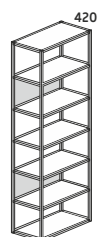

60H

60H

LF2R62 420x420x2220 1 800,-
LF1R62 800x420x2220 1 992,-

REGAŁ 40H, 50H, 60H
2x PLECY PŁYTOWE W STANDARDZIE
MONTOWANE W DOWOLNYM MIEJSCU
I Z DOWOLNEJ STRONY

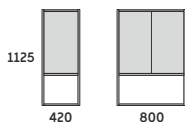
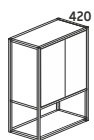

30H

30H

LF2R32/W2D2 420x420x1125 1 926,-
LF1R32/W1D2 800x420x1125 2 019,-

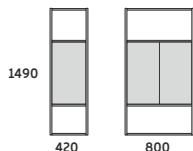
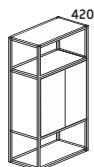

40H

40H

LF2R42/W2D2 420x420x1490 2 050,-
LF1R42/W1D2 800x420x1490 2 290,-

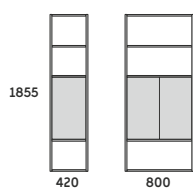
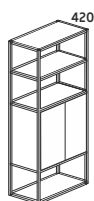

50H

50H

LF2R52/W2D2 420x420x1855 2 140,-
LF1R52/W1D2 800x420x1855 2 440,-

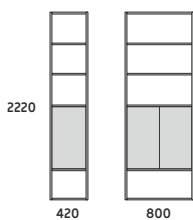
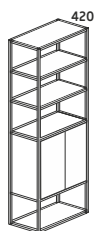

60H

60H

LF2R62/W2D2 420x420x2220 2 300,-
LF1R62/W1D2 800x420x2220 2 562,-

MAKSYMALNA WOLNA PRZESTRZEŃ POD SZAFKĄ: 1 OH

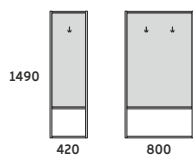
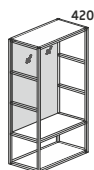

40H

40H

LF2U42 400x420x1490 1 620,-
LF1U42 780x420x1490 1 830,-

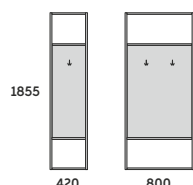
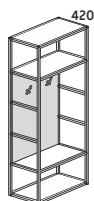

50H

50H

LF2U52 400x420x1855 1 710,-
LF1U52 780x420x1855 1 960,-

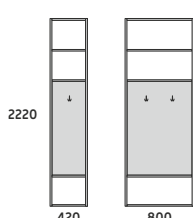
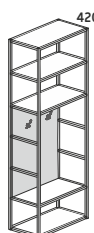

60H

60H

LF2U62 400x420x2220 1 870,-
LF1U62 780x420x2220 2 122,-

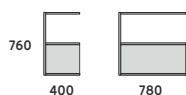
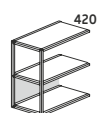

20H

20H

LF2R21 400x420x760 1 180,-
LF1R21 780x420x760 1 322,-

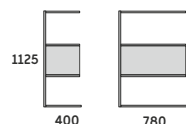
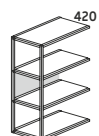

30H

30H

LF2R31 400x420x1125 1 230,-
LF1R31 780x420x1125 1 420,-

REGAŁ 20H, 30H
1x PLECY PŁYTOWE W STANDARDZIE
MONTOWANE W DOWOLNYM MIEJSCU
I Z DOWOLNEJ STRONY

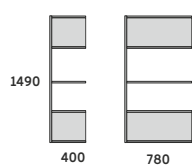
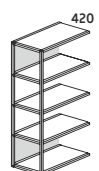

40H

40H

LF2R41 400x420x1490 1 393,-
LF1R41 780x420x1490 1 580,-

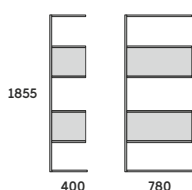
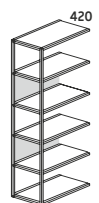

50H

50H

LF2R51 400x420x1855 1 459,-
LF1R51 780x420x1855 1 706,-

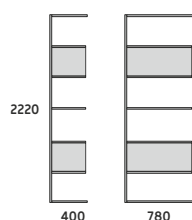
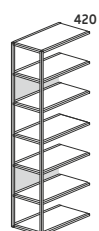

60H

60H

LF2R61 400x420x2220 1 597,-
LF1R61 780x420x2220 1 788,-

REGAŁ 40H, 50H, 60H
2x PLECY PŁYTOWE W STANDARDZIE
MONTOWANE W DOWOLNYM MIEJSCU
I Z DOWOLNEJ STRONY

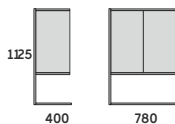
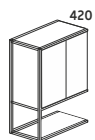

30H

30H

LF2R31/W2D2 400x420x1125 1 730,-
LF1R31/W1D2 780x420x1125 1 889,-

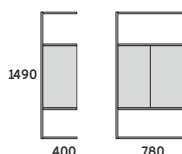
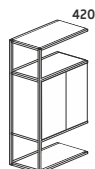

40H

40H

LF2R41/W2D2 400x420x1490 1 893,-
LF1R41/W1D2 780x420x1490 2 147,-

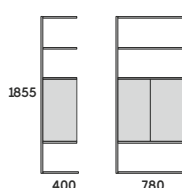
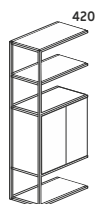

50H

50H

LF2R51/W2D2 400x420x1855 1 959,-
LF1R51/W1D2 780x420x1855 2 270,-

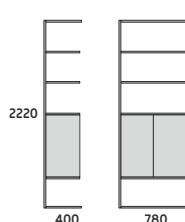
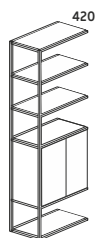

60H

60H

LF2R61/W2D2 400x420x2220 2 097,-
LF1R61/W1D2 780x420x2220 2 355,-

MAKSYMALNA WOLNA PRZESTRZEŃ POD SZAFKĄ: 1 OH

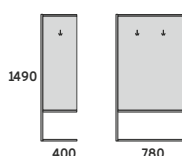
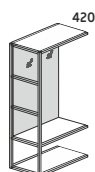

40H

40H

LF2U41 400x420x1490 1 450,-
LF1U41 780x420x1490 1 690,-

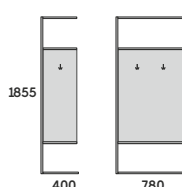
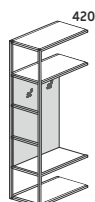

50H

50H

LF2U51 400x420x1855 1 520,-
LF1U51 780x420x1855 1 816,-

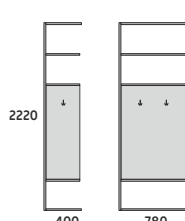
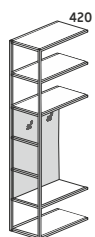

60H

60H

LF2U61 400x420x2220 1 657,-
LF1U61 780x420x2220 1 900,-

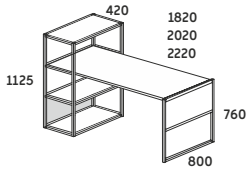

BIURKO+REGAŁ 30H
1x PLECY PŁYTOWE W STANDARDZIE
MONTOWANE W DOWOLNYM MIEJSCU
I Z DOWOLNEJ STRONY

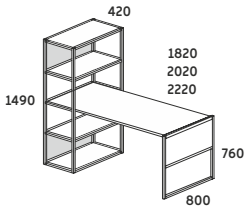

BIURKO Z REGAŁEM 30H

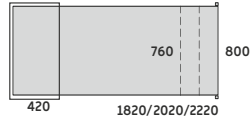

BIURKO Z REGAŁEM 40H

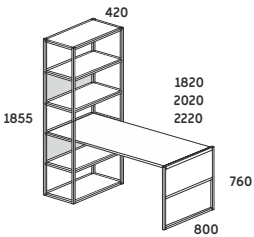
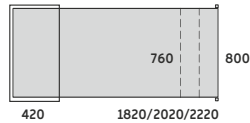

BIURKO Z REGAŁEM 50H

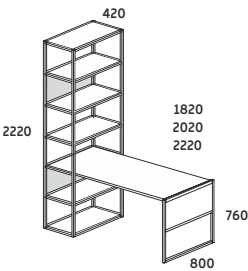
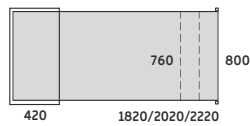

BIURKO+REGAŁ 40H, 50H, 60H
2x PLECY PŁYTOWE W STANDARDZIE
MONTOWANE W DOWOLNYM MIEJSCU
I Z DOWOLNEJ STRONY

BIURKO Z REGAŁEM 60H

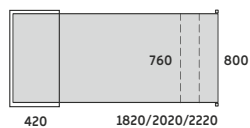

BIURKO Z REGAŁEM 30H

LF1R32/LF-B01	1820x800x760/1125	2 304,-
LF1R32/LF-B02	2020x800x760/1125	2 322,-
LF1R32/LF-B03	2220x800x760/1125	2 349,-

BIURKO Z REGAŁEM 40H

LF1R42/LF-B01	1820x800x760/1490	2 570,-
LF1R42/LF-B02	2020x800x760/1490	2 600,-
LF1R42/LF-B03	2220x800x760/1490	2 645,-

BIURKO Z REGAŁEM 50H

LF1R52/LF-B01	1820x800x760/1855	2 715,-
LF1R52/LF-B02	2020x800x760/1855	2 740,-
LF1R52/LF-B03	2220x800x760/1855	2 770,-

BIURKO Z REGAŁEM 60H

LF1R62/LF-B01	1820x800x760/2220	2 767,-
LF1R62/LF-B02	2020x800x760/2220	2 795,-
LF1R62/LF-B03	2220x800x760/2220	2 825,-

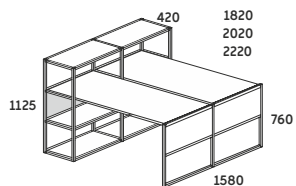

BENCH+REGAŁ 30H
1x PLECY PŁYTOWE W STANDARDZIE
MONTOWANE W DOWOLNYM MIEJSCU
I Z DOWOLNEJ STRONY

BENCH Z REGAŁEM 30H

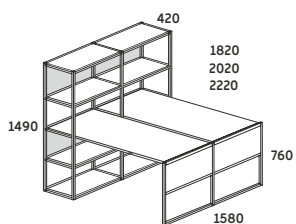
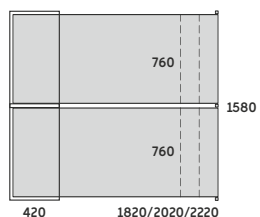

BENCH Z REGAŁEM 40H

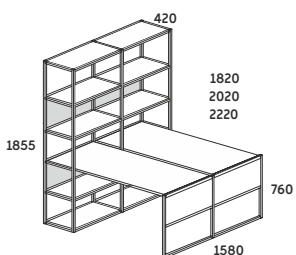
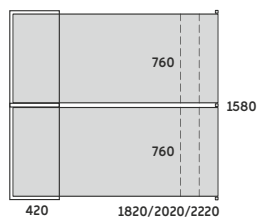

BENCH Z REGAŁEM 50H

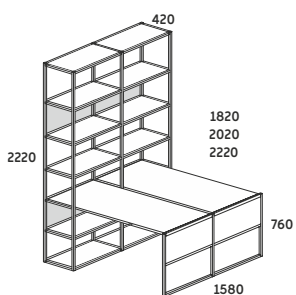
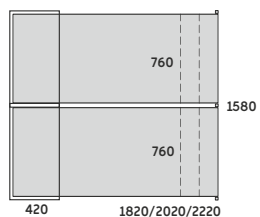

BENCH Z REGAŁEM 60H

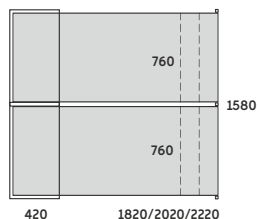

BENCH+REGAŁ 40H, 50H, 60H
2x PLECY PŁYTOWE W STANDARDZIE
MONTOWANE W DOWOLNYM MIEJSCU
I Z DOWOLNEJ STRONY

BENCH Z REGAŁEM 30H

LF1R33/LF-BE01	1820x1580x760/1125	3 069,-
LF1R33/LF-BE02	2020x1580x760/1125	3 130,-
LF1R33/LF-BE01	2220x1580x760/1125	3 200,-

BENCH Z REGAŁEM 40H

LF1R43/LF-BE01	1820x1580x760/1490	3 340,-
LF1R43/LF-BE02	2020x1580x760/1490	3 410,-
LF1R43/LF-BE02	2220x1580x760/1490	3 470,-

BENCH Z REGAŁEM 50H

LF1R53/LF-BE01	1820x1580x760/1855	3 490,-
LF1R53/LF-BE02	2020x1580x760/1855	3 560,-
LF1R53/LF-BE03	2220x1580x760/1855	3 620,-

BENCH Z REGAŁEM 60H

LF1R63/LF-BE01	1820x1580x760/2220	3 542,-
LF1R63/LF-BE02	2020x1580x760/2220	3 612,-
LF1R63/LF-BE03	2220x1580x760/2220	3 672,-

BIURKO WYSOKIE Z REGAŁEM

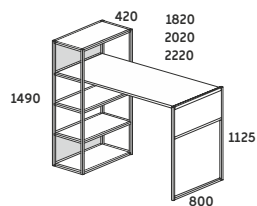

**BIURKO WYSOKIE
Z REGAŁEM 40H**

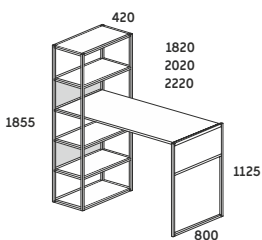
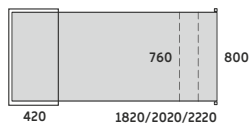

**BIURKO WYSOKIE
Z REGAŁEM 50H**

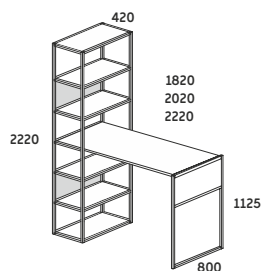
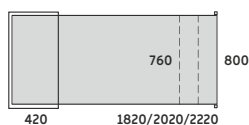

**BIURKO WYSOKIE
Z REGAŁEM 60H**

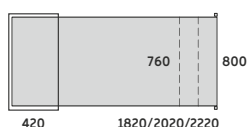

BIURKO+REGAŁ 40H, 50H, 60H
2x PLECY PŁYTOWE W STANDARDZIE
MONTOWANE W DOWOLNYM MIEJSCU
I Z DOWOLNEJ STRONY

**BIURKO
Z REGAŁEM 40H**

LF1R42/LF-BW01	1820x800x1125/1490	2 605,-
LF1R42/LF-BW02	2020x800x1125/1490	2 632,-
LF1R42/LF-BW03	2220x800x1125/1490	2 660,-

**BIURKO
Z REGAŁEM 50H**

LF1R52/LF-BW01	1820x800x1125/1855	2 755,-
LF1R52/LF-BW02	2020x800x1125/1855	2 788,-
LF1R52/LF-BW03	2220x800x1125/1855	2 810,-

**BIURKO
Z REGAŁEM 60H**

LF1R62/LF-BW01	1820x800x1125/2220	2 880,-
LF1R62/LF-BW02	2020x800x1125/2220	2 904,-
LF1R62/LF-BW03	2220x800x1125/2220	2 935,-

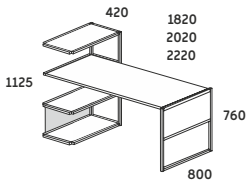

BIURKO+REGAŁ 30H
1x PLECY PŁYTOWE W STANDARDZIE
MONTOWANE W DOWOLNYM MIEJSCU
I Z DOWOLNEJ STRONY

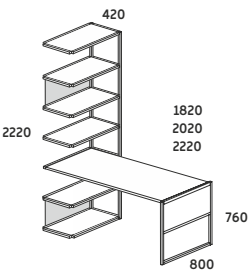
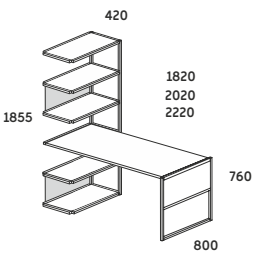
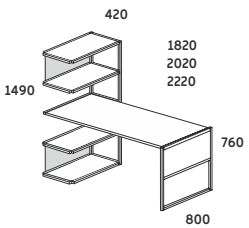

BIURKO+REGAŁ 40H, 50H, 60H
2x PLECY PŁYTOWE W STANDARDZIE
MONTOWANE W DOWOLNYM MIEJSCU
I Z DOWOLNEJ STRONY

BIURKO Z REGAŁEM 30H

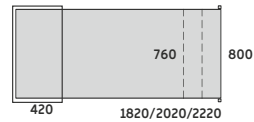

BIURKO Z REGAŁEM 40H

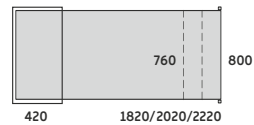

BIURKO Z REGAŁEM 50H

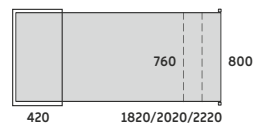

BIURKO Z REGAŁEM 60H

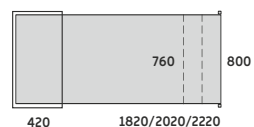

BIURKO Z REGAŁEM 30H

LF1R31/LF-B01	1820x800x760/1125	2 184,-
LF1R31/LF-B02	2020x800x760/1125	2 202,-
LF1R31/LF-B03	2220x800x760/1125	2 229,-

BIURKO Z REGAŁEM 40H

LF1R41/LF-B01	1820x800x760/1490	2 430,-
LF1R41/LF-B02	2020x800x760/1490	2 460,-
LF1R41/LF-B03	2220x800x760/1490	2 505,-

BIURKO Z REGAŁEM 50H

LF1R51/LF-B01	1820x800x760/1855	2 435,-
LF1R51/LF-B02	2020x800x760/1855	2 580,-
LF1R51/LF-B03	2220x800x760/1855	2 610,-

BIURKO Z REGAŁEM 60H

LF1R61/LF-B01	1820x800x760/2220	2 587,-
LF1R61/LF-B02	2020x800x760/2220	2 615,-
LF1R61/LF-B03	2220x800x760/2220	2 645,-

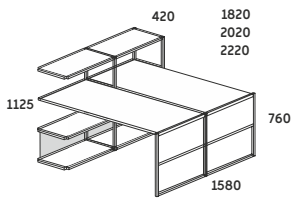

BENCH+REGAŁ 30H
1x PLECY PŁYTOWE W STANDARDZIE
MONTOWANE W DOWOLNYM MIEJSCU
I Z DOWOLNEJ STRONY

BENCH Z REGAŁEM 30H

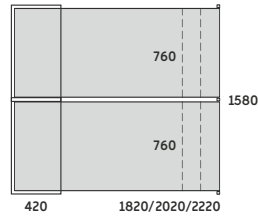

BENCH Z REGAŁEM 30H

LF1R34/LF-BE01	1820x1580x760/1125	2 949,-
LF1R34/LF-BE02	2020x1580x760/1125	3 010,-
LF1R34/LF-BE01	2220x1580x760/1125	3 080,-

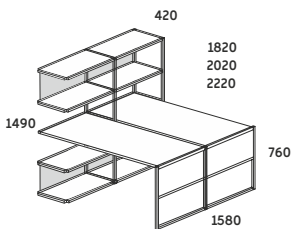

BENCH Z REGAŁEM 40H

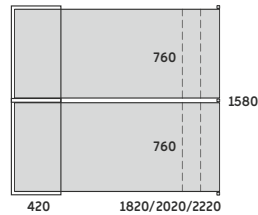

BENCH Z REGAŁEM 40H

LF1R44/LF-BE01	1820x1580x760/1490	3 200,-
LF1R44/LF-BE02	2020x1580x760/1490	3 270,-
LF1R44/LF-BE02	2220x1580x760/1490	3 330,-

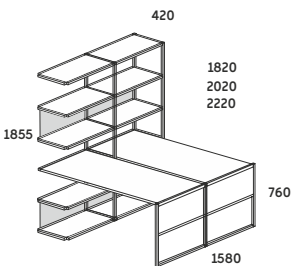

BENCH Z REGAŁEM 50H

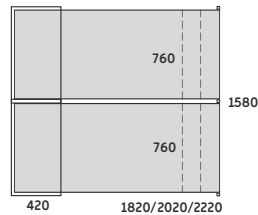

BENCH Z REGAŁEM 50H

LF1R54/LF-BE01	1820x1580x760/1855	3 330,-
LF1R54/LF-BE02	2020x1580x760/1855	3 400,-
LF1R54/LF-BE03	2220x1580x760/1855	3 460,-

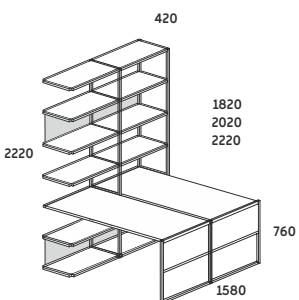

BENCH+REGAŁ 40H, 50H, 60H
2x PLECY PŁYTOWE W STANDARDZIE
MONTOWANE W DOWOLNYM MIEJSCU
I Z DOWOLNEJ STRONY

BENCH Z REGAŁEM 60H

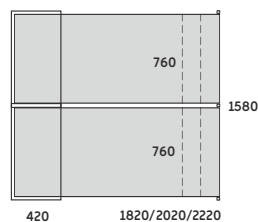

BENCH Z REGAŁEM 60H

LF1R64/LF-BE01	1820x1580x760/2220	3 362,-
LF1R64/LF-BE02	2020x1580x760/2220	3 432,-
LF1R64/LF-BE03	2220x1580x760/2220	3 492,-

BIURKO WYSOKIE Z REGAŁEM

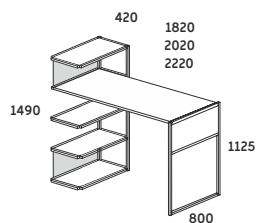

BIURKO WYSOKIE Z REGAŁEM 40H

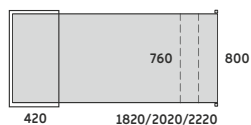

BIURKO Z REGAŁEM 40H

LF1R41/LF-BW01	1820x800x1125/1490	2 465,-
LF1R41/LF-BW02	2020x800x1125/1490	2 492,-
LF1R41/LF-BW03	2220x800x1125/1490	2 520,-

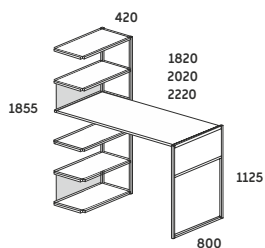

BIURKO WYSOKIE Z REGAŁEM 50H

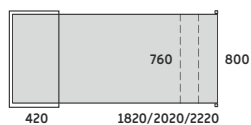

BIURKO Z REGAŁEM 50H

LF1R51/LF-BW01	1820x800x1125/1855	2 595,-
LF1R51/LF-BW02	2020x800x1125/1855	2 628,-
LF1R51/LF-BW03	2220x800x1125/1855	2 650,-

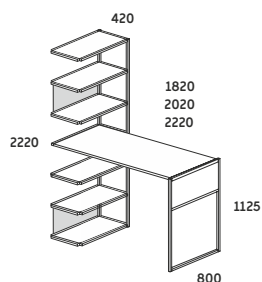

BIURKO WYSOKIE Z REGAŁEM 60H

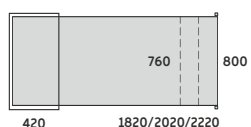

BIURKO Z REGAŁEM 60H

LF1R61/LF-BW01	1820x800x1125/2220	2 700,-
LF1R61/LF-BW02	2020x800x1125/2220	2 724,-
LF1R61/LF-BW03	2220x800x1125/2220	2 755,-

BIURKO+REGAŁ 40H, 50H, 60H
2x PLECY PŁYTOWE W STANDARDZIE
MONTOWANE W DOWOLNYM MIEJSCU
I Z DOWOLNEJ STRONY

ELEMENTY ROZSZERZAJĄCE

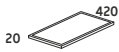

PÓŁKA



ELEMENT ROZSZERZAJĄCY REGAŁY
DO ŁĄCZENIA RÓŻNYCH WYSOKOŚCI

PÓŁKA

LF-P40 380x420x20	70,-
LF-P80 760x420x20	115,-

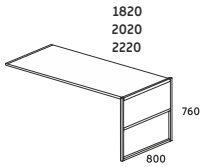

BIURKO NISKIE

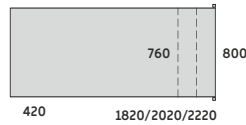

BIURKO NISKIE

LF-B01 1820x800x760	855,-
LF-B02 2020x800x760	880,-
LF-B03 2220x800x760	910,-

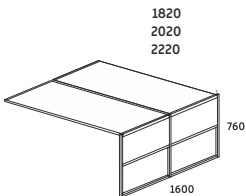

BENCH

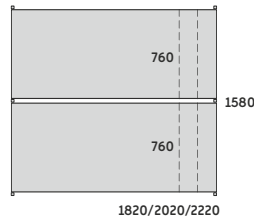

BENCH

LF-BE01 1820x800x760	1 590,-
LF-BE02 2020x800x760	1 640,-
LF-BE03 2220x800x760	1 890,-

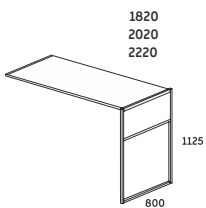

BIURKO WYSOKIE

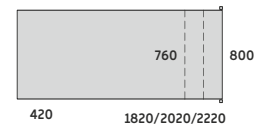

BIURKO WYSOKIE

LF-BW01 1820x800x760	886,-
LF-BW02 2020x800x760	912,-
LF-BW03 2220x800x760	940,-

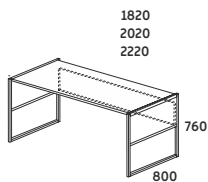

BIURKO

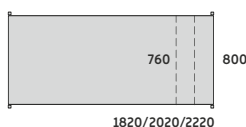

BIURKO

LF-B01 1820x800x760	990,-
LF-B02 2020x800x760	1 015,-
LF-B03 2220x800x760	1 060,-

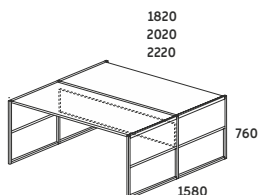

BENCH

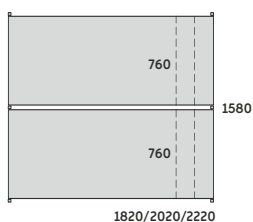

BENCH

LF-BE01 1820x1580x760	1 969,-
LF-BE02 2020x1580x760	2 020,-
LF-BE03 2220x1580x760	2 078,-

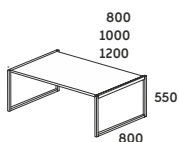

STOLIK

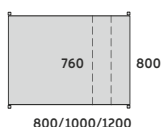

STOLIK

LF-S01 800x800x550	580,-
LF-S02 1000x800x550	609,-
LF-S03 1200x800x550	650,-

WKŁADY



WKŁAD/SZAFKA



WKŁAD/SZAFKA

LF-R40 380x416x345	240,-
LF-R80 760x416x345	329,-

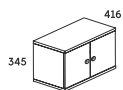

WKŁAD/SZAFKA ZAMYKANA

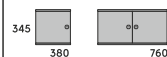

ZAMEK
SZYFROWY (S)



ZAMEK
ELEKTRONICZNY (P)

WKŁAD/SZAFKA ZAMYKANA

LF-R40/P 380x416x345	592,-
LF-R80/P 760x416x345	846,-
LF-R40/S 380x416x345	592,-
LF-R80/S 760x416x345	846,-

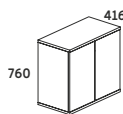

DRZWI OTWIERANE
ZA POMOCĄ TIP-ON

WKŁAD/SZAFKA

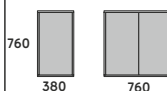

WKŁAD/SZAFKA

LF-W2D2 380x416x345	465,-
LF-W1D2 760x416x345	602,-

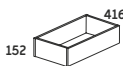

KWIETNIK



KWIETNIK

LF-K40 380x416x152	85,-
LF-K80 760x416x152	135,-

PLECY REGAŁÓW

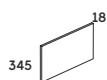

PLECY PŁYTOWE



PLECY PŁYTOWE

LF-PP40 380x345x18	54,-
LF-PP80 760x345x18	75,-

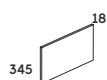

PLECY PET



PLECY PET

LF-PT40 380x345x18	190,-
LF-PT80 760x345x18	325,-

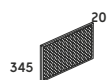

PLECY SIATKA



PLECY SIATKA

LF-PS40 380x345x20	282,-
LF-PS80 760x345x20	399,-

PLECY PASUJĄ RÓWNIŻ DO WYPEŁNIENIA RAM BIUREK

BIURKO ELEKTRYCZNE

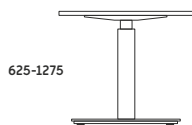

BIURKO ELEKTRYCZNE InUP 700

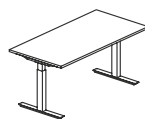
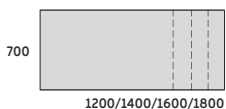

InUP PODNOSZONE 700

INZ-701 1200x700x625-1275	3 131,-
INZ-702 1400x700x625-1275	3 163,-
INZ-703 1600x700x625-1275	3 182,-
INZ-704 1800x700x625-1275	3 201,-

BLAT BIURKA: 25MM
METALOWA NOGA BIURKA
METALOWA STOPA
PŁYNNĄ REGULACJĄ W ZAKRESIE:
625-1275MM

BIURKO ELEKTRYCZNE InUP 800

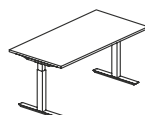

InUP PODNOSZONE 800

INZ-01 1200x800x625-1275	3 135,-
INZ-02 1400x800x625-1275	3 168,-
INZ-03 1600x800x625-1275	3 187,-
INZ-04 1800x800x625-1275	3 206,-

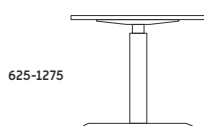

BIURKO ELEKTRYCZNE InUP 800

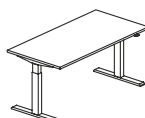
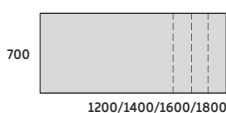

InUP PODNOSZONE 800

INZ-01/DS 1200x800x625-1275	3 528,-
INZ-02/DS 1400x800x625-1275	3 561,-
INZ-03/DS 1600x800x625-1275	3 580,-
INZ-04/DS 1800x800x625-1275	3 599,-

BLAT BIURKA: 25MM
METALOWA NOGA BIURKA
DREWNIANA STOPA
PŁYNNĄ REGULACJĄ W ZAKRESIE:
625-1275MM

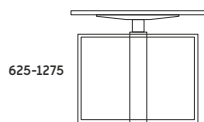

BIURKO ELEKTRYCZNE InUP 800

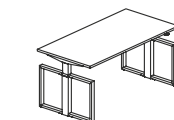

InUP PODNOSZONE 800

INZ-01/DO 1200x800x625-1275	4 027,-
INZ-02/DO 1400x800x625-1275	4 060,-
INZ-03/DO 1600x800x625-1275	4 079,-
INZ-04/DO 1800x800x625-1275	4 098,-

BLAT BIURKA: 25MM
DEWNIANA NOGA BIURKA
PŁYNNĄ REGULACJĄ W ZAKRESIE:
625-1275MM

BIURKO BENCH ELEKTRYCZNE InUP 1450

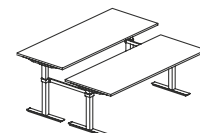
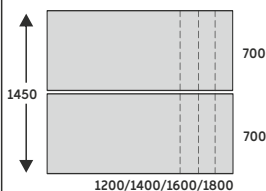

InUP PODNOSZONE 1450

INZBE-1401 1200x1450x625-1275	6 357,-
INZBE-1402 1400x1450x625-1275	6 412,-
INZBE-1403 1600x1450x625-1275	6 440,-
INZBE-1404 1800x1450x625-1275	6 493,-

BIURKO BENCH ELEKTRYCZNE InUP 1650

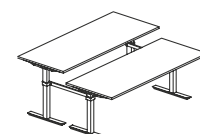
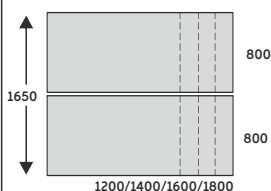

InUP PODNOSZONE 1650

INZBE-01 1200x1650x625-1275	6 367,-
INZBE-02 1400x1650x625-1275	6 421,-
INZBE-03 1600x1650x625-1275	6 450,-
INZBE-04 1800x1650x625-1275	6 502,-

BLAT BIURKA: 25MM
METALOWA NOGA BIURKA
METALOWA STOPA
PŁYNNĄ REGULACJĄ W ZAKRESIE:
625-1275MM

PRZEGRODA TAPICEROWANA

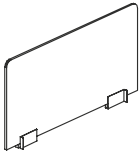

PRZEGRODA TAPICEROWANA
WYSOKOŚĆ 800MM, GR: 25MM
KOLORY: PRÓBNIK

PRZEGRODA TAPICEROWANA

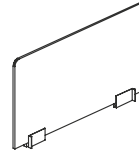
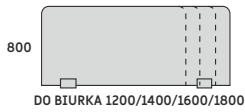

PRZEGRODA TAPICEROWANA

INPT-01 DO BIURKA 1200	897,-
INPT-02 DO BIURKA 1400	982,-
INPT-03 DO BIURKA 1600	1 068,-
INPT-04 DO BIURKA 1800	1 153,-

- PILOT W CENIE BIURKA
- MAKSYMALNA SZYBKOŚĆ PODNOSZENIA [mm/s] 38
- GŁOŠNOŚĆ [dB] < 50
- PŁYNNA REGULACJA WYSOKOŚCI
- SYSTEM SOFT START-STOP, ŁAGODNY START I ZATRZYMANIE
- SYSTEM ANTYKOLIZYJNY, 3 POZIOMY CZUŁOŚCI.
- SYSTEM ANTYKOLIZYJNY PRZECIĄŻENIOWY, SYSTEM AKTYWOWANY JEST PO KONTAKCIE ZE STABILNĄ PRZESZKODĄ.
- PAMIĘĆ WYSOKOŚCI 4 POZYCJE
- WYŚWIETLACZ LCD, AKTUALNA WYSOKOŚĆ
- ZŁĄCZA USB (ŁADOWARKA) QC2.0/QC3.0, 5.0V / 9.0V / 12.0V, 1A ±5%
- BŁOKADA RODZICIELSKA
- NAPĘD 2 SILNIKI Z SYNCHRONIZACJĄ STEROWANE PRZEZ MIKROPROCESOR
- ZABEZPIECZENIE PRZECIW PRZEGRZANIU
- ZASILANIE 100 - 240V AC
- ZUŻYCIĘ ENERGII W TRYBIE STANDBY [W] < 0,5
- DODATKOWE FUNKCJE: OGRANICZENIE MINIMALNEJ I MAKSYMALNEJ WYSOKOŚCI.
- ZMIANY WYŚWIETLANEJ WYSOKOŚCI BIURKA (W ZALEŻNOŚCI OD GRUBOŚCI BLATU).

DANE TECHNICZNE NAPĘDU

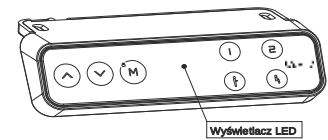

- ^ - PODNOSZENIE BIURKA
- v - OBNIŻANIE BIURKA
- 1 - PIERWSZA ZAPAMIĘTANA WYSOKOŚĆ BIURKA
- 2 - DRUGA ZAPAMIĘTANA WYSOKOŚĆ BIURKA
- 3 - TRZECIA ZAPAMIĘTANA WYSOKOŚĆ, POZYCJA STOJĄCA
- 4 - CZWARTA ZAPAMIĘTANA WYSOKOŚĆ, POZYCJA SIEDZĄCA
- M - PRZYCIŚK ZAPISANIA WYSOKOŚCI;
- WŁĄCZ/WYŁĄCZ BŁOKADĘ PRZED DZIEĆMI
- PORT USB (ŁADOWANIE) - QC2.0/QC3.0, 5.0V / 9.0V / 12.0V, 1A ±5%

PRZELOTKI KABLOWE

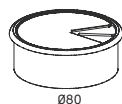

Ø80

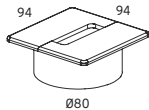

Ø80

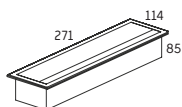

PRZELOTKA OKRĄGŁA
PR Ø80 21,-

PRZELOTKA KWADRAT
KWP 94x94 Ø80 38,-

PRZELOTKA KABLOWA
PK 271x114x85 279,-

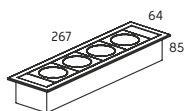

MB01 MEDIABOX OTWARTY
4x 230V

MB02 MEDIABOX OTWARTY
3x 230V + 2x RJ45 kat. 5e UTP

MB02H MEDIABOX OTWARTY
2x 230V + 2x RJ45 kat. 5e UTP + 1x HDMI

MEDIABOX OTWARTY

MB-01 267x64x85 649,-

MB-02 267x64x85 896,-

MB-02H 267x64x85 1 170,-

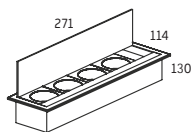

MB03 MEDIABOX ZAMYKANY
4x 230V

MB04 MEDIABOX ZAMYKANY
3x 230V + 2x RJ45 kat. 5e UTP

MB04H MEDIABOX ZAMYKANY
2x 230V + 2x RJ45 kat. 5e UTP + 1x HDMI

MEDIABOX ZAMYKANY

MB-03 271x114x130 709,-

MB-04 271x114x130 942,-

MB-04H 271x114x130 1 181,-

MEDIABOXY

ORGANIZACJA KABLI

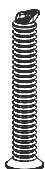

KRĘGOSŁUP NA KABELE

KRĘGOSŁUP NA KABELE

KR-02 73x150x500-1300 346,-

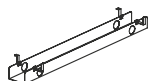

KORYTO METALOWE NA KABELE

KORYTO METALOWE NA KABELE

KIN-01 DO BIURKA 1200 274,-

KIN-02 DO BIURKA 1400 297,-

KIN-03 DO BIURKA 1600 319,-

KIN-04 DO BIURKA 1800 349,-

KIN-05 DO BIURKA 2000 362,-



POZIOME PROWADZENIE KABLI

POZIOME PROWADZENIE KABLI

GR 1000x68x35 88,-

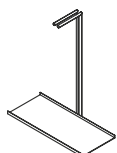

WIESZAK METALOWY NA PC

WIESZAK METALOWY NA PC

ZK 224x500x515 350,-

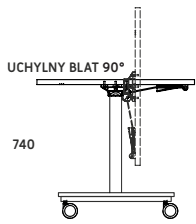

BLAT : 25MM
METALOWA NOGA
METALOWA STOPA
UCHYLNÝ BLAT 90°

STÓŁ Z BLATEM UCHYLNÝM PROSTY 700

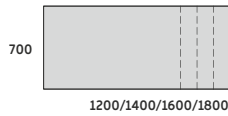

STÓŁ Z BLATEM UCHYLNÝM PROSTY 800



STÓŁ 180° Z BLATEM UCHYLNÝM

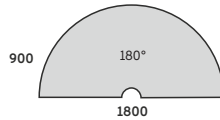

STÓŁ 120° Z BLATEM UCHYLNÝM

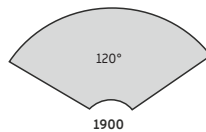

STÓŁ Z BLATEM UCHYLNÝM PROSTY 700



STÓŁ Z BLATEM UCHYLNÝM PROSTY 800

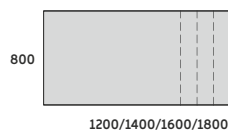

STÓŁ 180° Z BLATEM UCHYLNÝM

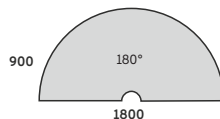

STÓŁ 120° Z BLATEM UCHYLNÝM

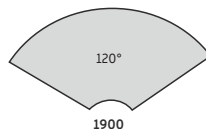

SPINKI ŁĄCZĄCE BLATY KOMPLET - 2 SZTUKI

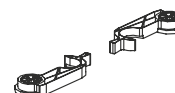
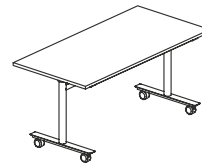
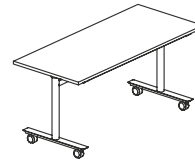
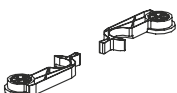

STÓŁ PROSTY 700

LIP-701 1200x700x740 1 583,-
LIP-702 1400x700x740 1 681,-
LIP-703 1600x700x740 1 711,-
LIP-704 1800x700x740 1 757,-

STÓŁ PROSTY 800

LIP-01 1200x800x740 1 585,-
LIP-02 1400x800x740 1 683,-
LIP-03 1600x800x740 1 714,-
LIP-04 1800x800x740 1 760,-

STÓŁ 180°

LI-180 1800x900x740 1 716,-

STÓŁ 120°

LI-120 1900x950x740 1 763,-

STÓŁ PROSTY 700

LIY-701 1200x700x740 1 488,-
LIY-702 1400x700x740 1 578,-
LIY-703 1600x700x740 1 606,-
LIY-704 1800x700x740 1 659,-

STÓŁ PROSTY 800

LIY-01 1200x800x740 1 490,-
LIY-02 1400x800x740 1 582,-
LIY-03 1600x800x740 1 612,-
LIY-04 1800x800x740 1 656,-

STÓŁ 180°

LIY-180 1800x900x740 1 625,-

STÓŁ 120°

LIY-120 1900x950x740 1 660,-

SPINKI ŁĄCZĄCE BLATY

SP2 92,-

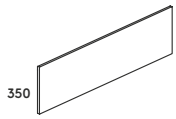

PANEL FRONTOWY DO STOŁÓW PROSTYCH Z BLATEM UCHYLNYM

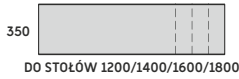

DO STOŁÓW 1200/1400/1600/1800

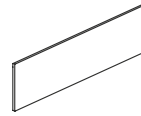

STÓŁ PROSTY 800

LIBL-01 DO 1200	181,-
LIBL-02 DO 1400	195,-
LIBL-03 DO 1600	207,-
LIBL-04 DO 1800	221,-

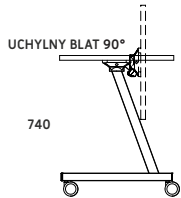

STOLIK Z BLATEM UCHYLNYM



STOLIK

STOLIK

SK-01 600x600x740	799,-
-------------------	-------

STOŁY KONFERENCYJNE ROZKŁADANE

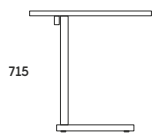

STÓŁ ROZKŁADANY MAŁY

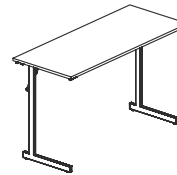

STÓŁ ROZKŁADANY MAŁY

SKM-01 1200x500x715	662,-
---------------------	-------

BLAT : 18MM
PROFIL STELAŻA 40x20MM

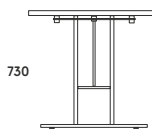

STÓŁ ROZKŁADANY DUŻY

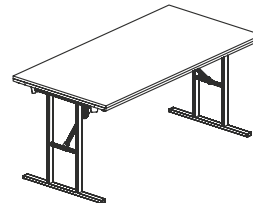

STÓŁ ROZKŁADANY DUŻY

SKD-02 1600x800x730	904,-
SKD-04 2000x800x730	945,-

BLAT : 25MM
PROFIL STELAŻA 40x20MM

WÓZEK

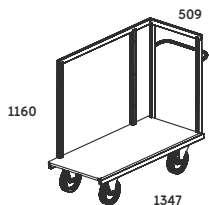

WÓZEK MAŁY DO STOŁÓW SKM

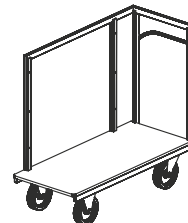

WÓZEK MAŁY

WM 1347x509x1160	1 967,-
------------------	---------

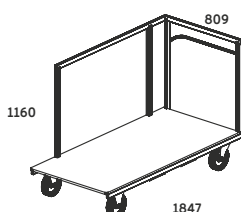

WÓZEK DUŻY DO STOŁÓW SKD

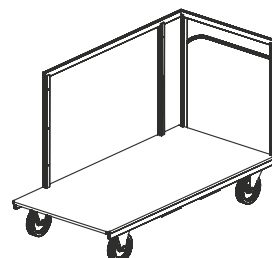

WÓZEK DUŻY

WD 1847x809x1160	2 346,-
------------------	---------

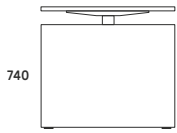

BLAT BIURKA: 25MM
NOGA BIURKA: 86MM
PŁYNNĄ REGULACJĄ W ZAKRESIE:
625-1275MM

BIURKO ELEKTRYCZNE InUP

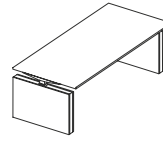
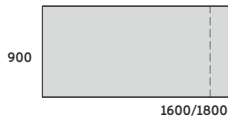

InUP		
INGB-01	1600x900x625/1275	6 249,-
INGB-02	1800x900x625/1275	6 286,-

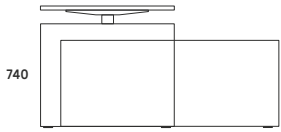

BIURKO:
BLAT BIURKA: 25MM
NOGA BIURKA: 86MM
METALOWY STELAŻ
PŁYNNĄ REGULACJĄ W ZAKRESIE:
625-1275MM

BIURKO ELEKTRYCZNE PRAWO InUP

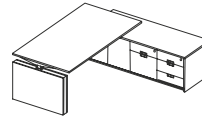
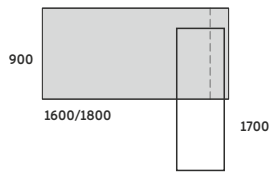

InUP		
INGB/SP-01P	1600x900x625/1275	9 571,-
INGB/SP-02P	2180x900x625/1275	9 599,-

BIURKO LEWE PRESTIGE

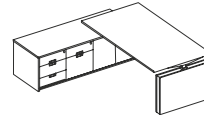
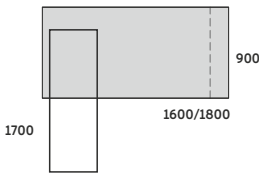

InUP		
INGB/SP-01L	1980x900x625/1275	9 571,-
INGB/SP-02L	2180x900x625/1275	9 599,-

SZAFKA LEWA/PRAWA
WYMIARY 1602x624x535 MM:
BLAT: 25 MM
KORPUS: 18 MM
SZUFLADY METALOWE-WYSUW 80%
SZUFLADY-CICHY DOMYK

BIURKO Z SZAFKĄ



-TOP 18MM
-KORPUS 18MM
-FRONTY SZUFLAD 18MM
-ZAMEK CENTRALNY
-CICHY DOMYK W STANDARDZIE

KONTENER MOBILNY



KONTENER

KONTENER		
INGK 430x573x530		1 399,-

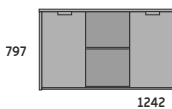

KOMODA



KOMODA		
INS12R2	1242x435x797	2 053,-

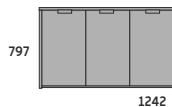

KOMODA		
INS12D2	1242x435x797	2 250,-

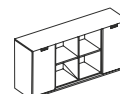
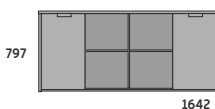

KOMODA		
INS16R2	1642x435x797	2 560,-

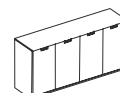
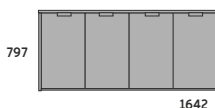

KOMODA		
INS16D2	1642x435x797	2 988,-

-TOP 18MM
-KORPUS 18MM
-FRONTY DRZWI 18MM
-PÓŁKI 18MM

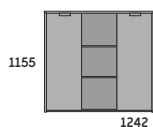

SZAFKA 3OH

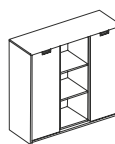

SZAFKA
INS12R3 1242x435x1155 2 533,-

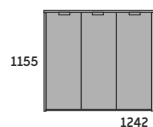

SZAFKA 3OH

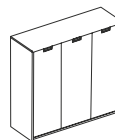

SZAFKA
INS12D3 1242x435x1155 2 774,-

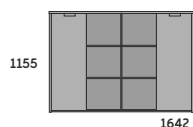

SZAFKA 3OH

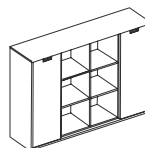

SZAFKA
INS16R3 1642x435x1155 3 110,-

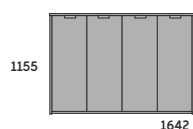

SZAFKA 3OH

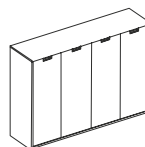

SZAFKA
INS16D3 1642x435x1155 3 625,-

-TOP 18MM
-KORPUS 18MM
-FRONTY DRZWI 18MM
-PÓŁKI 18MM

SZAFKA 4OH

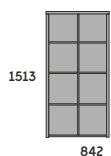

SZAFKA 4OH

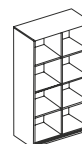
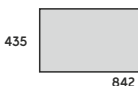

SZAFKA
INS8R4 842x435x1513 1 751,-

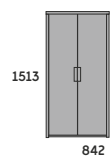

SZAFKA 4OH

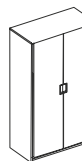

SZAFKA
INS8D4 842x435x1513 2 427,-

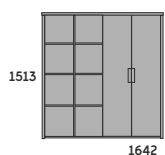

SZAFKA 4OH

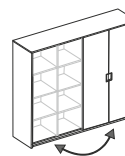

SZAFKA
INS16RD4 1642x435x1513 3 773,-

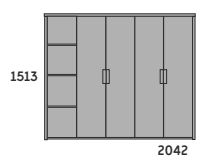

SZAFKA 4OH

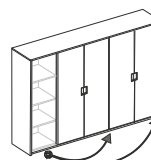

SZAFKA
INS20RD4 2042x435x1513 5 109,-

-TOP 18MM
-KORPUS 18MM
-FRONTY DRZWI 18MM
-PÓŁKI 18MM

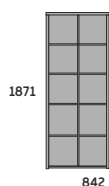

SZAFKA 50H

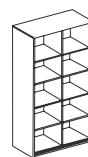

SZAFKA

INS8R5 842x435x1871 1 995,-



SZAFKA 50H

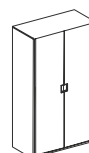

SZAFKA

INS8D5 842x435x1871 2 691,-

INS8U5 842x435x1871 2 344,-

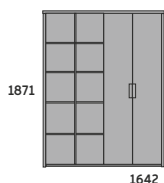

SZAFKA 50H

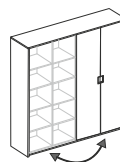

SZAFKA

INS16RD5 1642x435x1871 4 212,-

INS16RU5 1642x435x1871 3 865,-

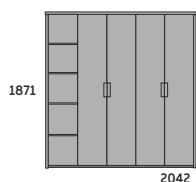

SZAFKA 50H

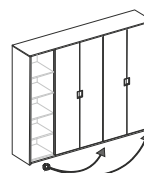
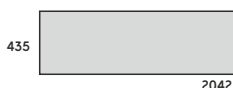

SZAFKA

INS20DD5 2042x435x1871 5 679,-

INS20DU5 2042x435x1871 5 331,-

-TOP 18MM
-KORPUS 18MM
-FRONTY DRZWI 18MM
-PÓŁKI 18MM

DRZWI SZKLANE W RAMCE ALUMINIOWEJ DO SZAF 30H

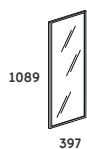

1089

397

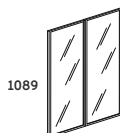

1089

796

-RAMKA ALUMINIOWA
-SZKŁO SATYNA



DRZWI SZKLANE
INS3/1 397x20x1089 789,-

DRZWI SZKLANE
INS3/2 796x20x1089 1 546,-

DRZWI SZKLANE W RAMCE ALUMINIOWEJ DO SZAF 40H



1447

397

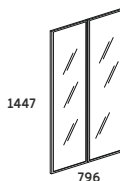

1447

796

-RAMKA ALUMINIOWA
-SZKŁO SATYNA



DRZWI SZKLANE
INS4/1 397x20x1447 1 061,-

DRZWI SZKLANE
INS4/2 796x20x1447 2 101,-

DRZWI SZKLANE

DRZWI SZKLANE W RAMCE ALUMINIOWEJ DO SZAF 50H



1805

397



1805

796

-RAMKA ALUMINIOWA
-SZKŁO SATYNA



DRZWI SZKLANE
INS5/1 397x20x1805 1 209,-

DRZWI SZKLANE
INS5/2 796x20x1805 2 386,-

DRZWI SZKLANE

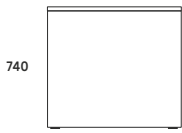

BIURKO PRESTIGE

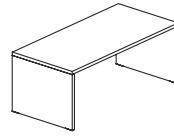
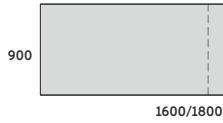

PRESTIGE	
PRB 01 1600x900x740	2 201,-
PRB 02 1900x900x740	2 286,-

BIURKO Z SZAFKĄ

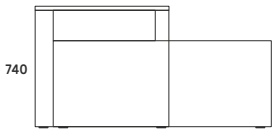

BIURKO PRAWE PRESTIGE

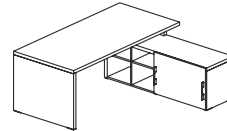
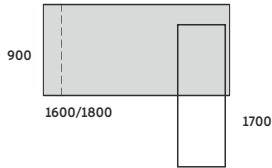

PRESTIGE	
PRSB 01 P 1600x900/1700x740	3 830,-
PRSB 02 P 1900x900/1700x740	4 182,-

BIURKO:
BLAT BIURKA: 39 MM
NOGA BIURKA: 39 MM
BLENDY BIURKA: 18 MM
STOPKA ZE STALI: 10 MM

SZAFKA LEWA/PRAWA
WYMIARY 1532x470x430 MM:
KORPUS: 18 MM
BLAT: 39 MM
BOK: 39 MM
STOPKA ZE STALI: 10 MM

BIURKO LEWE PRESTIGE

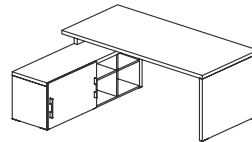
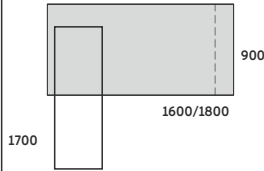

PRESTIGE	
PRSB 01 L 1600x900/1700x740	3 830,-
PRSB 02 L 1900x900/1700x740	4 182,-

DOSTAWKA

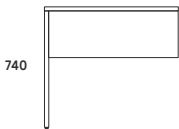

DOSTAWKA PRESTIGE

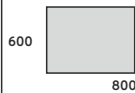

DOSTAWKA PRAWA PRESTIGE	
PRD P 800x600x740	1 092,-

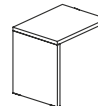

DOSTAWKA LEWA PRESTIGE	
PRD L 800x600x740	1 092,-

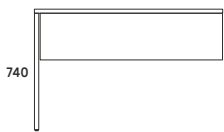

DOSTAWKA KONFERENCYJNA PRESTIGE

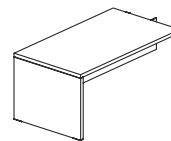

DOSTAWKA KONFERENCYJNA	
PRDK 1600x900x740	1 534,-

BLAT BIURKA: 39 MM
NOGA BIURKA: 39 MM
BLENDY BIURKA: 18 MM
STOPKA ZE STALI: 10 MM

STOŁY



STOLIK NISKI PRESTIGE

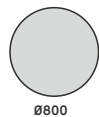

STOLIK NISKI	
PRO Ø800x550	1 070,-

STÓŁ PRESTIGE

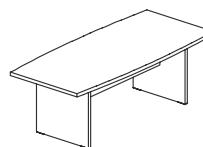
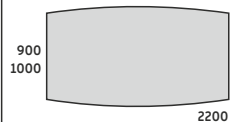

STÓŁ KONFERENCYJNY	
PRS 2200x900/1000x740	2 179,-

BLAT : 39 MM
NOGA : 39 MM
BLENDY : 18 MM
STOPKA ZE STALI: 10 MM



571
430
-TOP 39MM
-KORPUS 18MM
-FRONTY SZUFLAD 18MM
-ZAMEK CENTRALNY
-CICHY DOMYK W STANDARDZIE

KONTENER MOBILNY

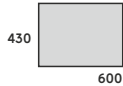

KONTENER
PRK 430x600x571 1 314,-

SZAFKA POMOCNIK PRAWA

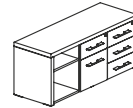
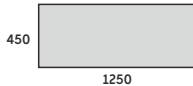

SZAFKA POMOCNIK
PRAWA
PRSP P 1250x450x530 2 773,-

SZAFKA POMOCNIK LEWA

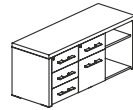

SZAFKA POMOCNIK
LEWA
PRSP L 1250x450x530 2 773,-

KOMODA

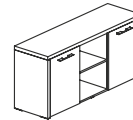
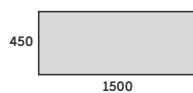
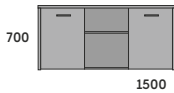

KOMODA
PRKM 1500x450x700 2 144,-

-TOP 39MM
-BOK 39MM
-FRONTY SZUFLAD/DRZWI 18MM
-ZAMEK CENTRALNY
-CICHY DOMYK W STANDARDZIE

SZAFKA POMOCNIK

REGAŁ 30H

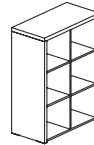
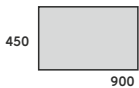
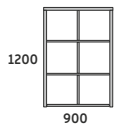

REGAŁ 30H
PR3R 900x450x1200 1 898,-

REGAŁ 30H DRZWI SZKLANE

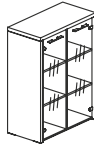
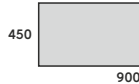
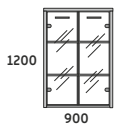

SZAFKA 30H
DRZWI SZKLANE
PR3S 900x450x1200 3 044,-

REGAŁ 30H DRZWI PŁYTOWE

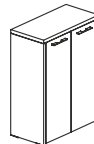
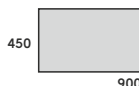
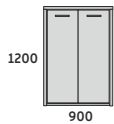

SZAFKA 30H
DRZWI PŁYTOWE
PR3D 900x450x1200 2 374,-

SZAFKA 30H DRZWI PŁYTOWE/REGAŁ

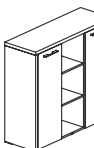
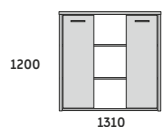

SZAFKA 30H
DRZWI PŁYTOWE/REGAŁ
PR3D2/R1 1310x450x1200 3 037,-

SZAFKA 30H DRZWI PŁYTOWE/SZKLANE

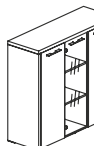
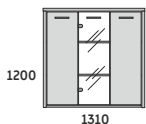

SZAFKA 30H
DRZWI PŁYTOWE/SZKLANE
PR3D2/S1 1310x450x1200 3 661,-

-TOP 39MM
-BOK 39MM
-PÓŁKI 18MM
-FRONTY DRZWI 18MM
-STOPKA ZE STALI 10MM

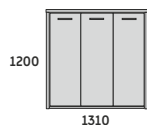

**SZAFKA 30H
DRZWI PŁYTOWE**

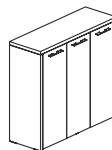

**SZAFKA 30H
DRZWI PŁYTOWE**
PR3D3 1310x450x1200 3 271,-

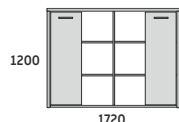

**SZAFKA 30H
DRZWI PŁYTOWE/REGAŁ**

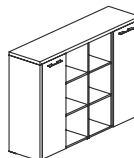

**SZAFKA 30H
DRZWI PŁYTOWE/REGAŁ**
PR3D2/R2 1720x450x1200 3 577,-

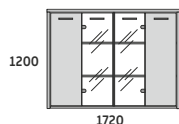

**SZAFKA 30H
DRZWI PŁYTOWE/SZKLANE**

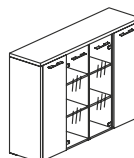

**SZAFKA 30H
DRZWI PŁYTOWE/SZKLANE**
PR3D2/S2 1720x450x1200 4 550,-

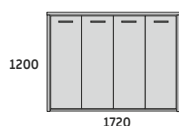

**SZAFKA 30H
DRZWI PŁYTOWE/SZKLANE**

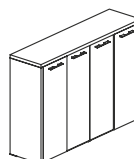

**SZAFKA 30H
DRZWI PŁYTOWE**
PR3D4 1720x450x1200 3 862,-

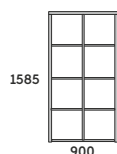

REGAŁ 40H

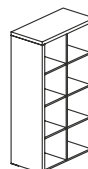
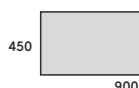

REGAŁ 40H
PR4R 900x450x1585 2 340,-

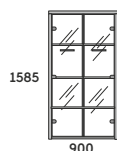

**REGAŁ 40H
DRZWI SZKLANE**

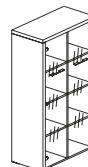
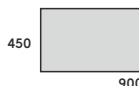

**SZAFKA 40H
DRZWI SZKLANE**
PR4S 900x450x1585 3 989,-

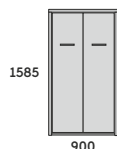

**REGAŁ 40H
DRZWI PŁYTOWE**

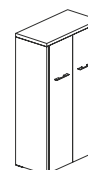
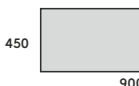

**SZAFKA 40H
DRZWI PŁYTOWE**
PR4D 900x450x1585 2 915,-

-TOP 39MM
-BOK 39MM
-PÓŁKI 18MM
-FRONTY DRZWI 18MM
-STOPKA ZE STALI 10MM

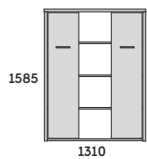

**SZAFKA 40H
DRZWI PŁYTOWE/REGAŁ**

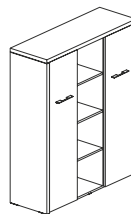

**SZAFKA 40H
DRZWI PŁYTOWE/REGAŁ**
PR4D2/R1 1310x450x1585 3 857,-

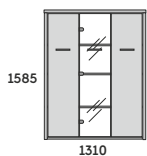

**SZAFKA 40H
DRZWI PŁYTOWE/SZKLANE**

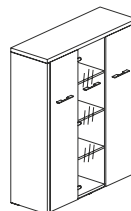

**SZAFKA 40H
DRZWI PŁYTOWE/SZKLANE**
PR4D2/S1 1310x450x1585 4 509,-

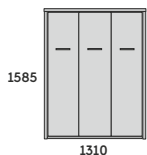

**SZAFKA 40H
DRZWI PŁYTOWE**

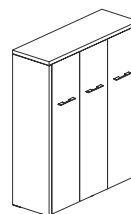

**SZAFKA 40H
DRZWI PŁYTOWE**
PR4D3 1310x450x1585 3 624,-

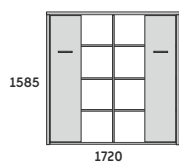

**SZAFKA 40H
DRZWI PŁYTOWE/REGAŁ**

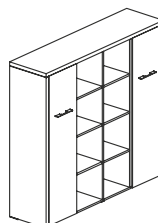

**SZAFKA 40H
DRZWI PŁYTOWE/REGAŁ**
PR4D2/R2 1720x450x1585 3 960,-

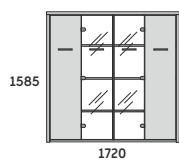

**SZAFKA 40H
DRZWI PŁYTOWE/SZKLANE**

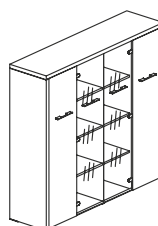

**SZAFKA 40H
DRZWI PŁYTOWE/SZKLANE**
PR4D2/S2 1720x450x1585 5 262,-

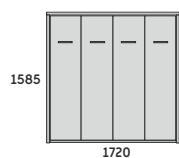

**SZAFKA 40H
DRZWI PŁYTOWE/SZKLANE**

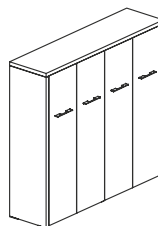

**SZAFKA 40H
DRZWI PŁYTOWE**
PR4D4 1720x450x1585 4 368,-

-TOP 39MM
-BOK 39MM
-PÓŁKI 18MM
-FRONTY DRZWI 18MM
-STOPKA ZE STALI 10MM

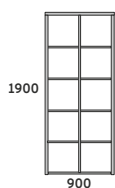

REGAŁ 50H

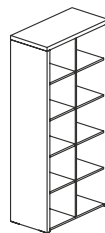

REGAŁ 50H

PR6R 900x450x1900

2 670,-

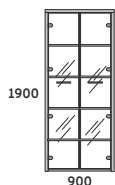

**REGAŁ 50H
DRZWI SZKLANE**

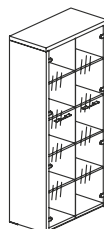

SZAFKA 50H

DRZWI SZKLANE

PR6S 900x450x1900

4 375,-

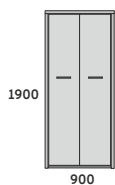

**REGAŁ 50H
DRZWI PŁYTOWE**

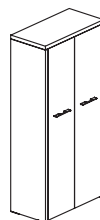
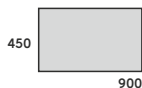

SZAFKA 50H

DRZWI PŁYTOWE

PR6D 900x450x1900

3 311,-

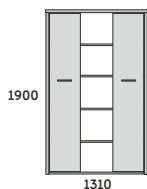

**SZAFKA 50H
DRZWI PŁYTOWE/REGAŁ**

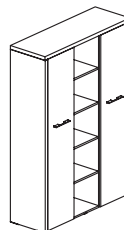

SZAFKA 50H

DRZWI PŁYTOWE/REGAŁ

PR6D2/R1 1310x450x1900

4 020,-

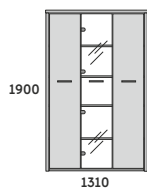

**SZAFKA 50H
DRZWI PŁYTOWE/SZKLANE**

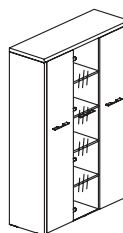

SZAFKA 50H

DRZWI PŁYTOWE/SZKLANE

PR6D2/S1 1310x450x1900

4 771,-

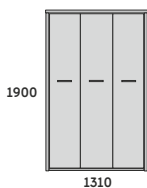

**SZAFKA 50H
DRZWI PŁYTOWE**

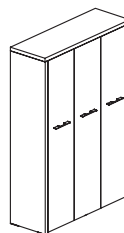

SZAFKA 50H

DRZWI PŁYTOWE

PR6D3 1310x450x1900

4 349,-

-TOP 39MM
-BOK 39MM
-PÓŁKI 18MM
-FRONTY DRZWI 18MM
-STOPKA ZE STALI 10MM

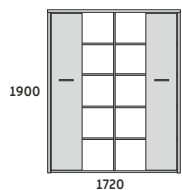

**SZAFKA 50H
DRZWI PŁYTOWE/REGAŁ**

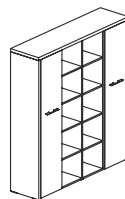

**SZAFKA 50H
DRZWI PŁYTOWE/REGAŁ**
PR6D2/R2 1720x450x1900 4 472,-

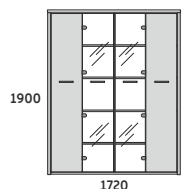

**SZAFKA 50H
DRZWI PŁYTOWE/SZKLANE**

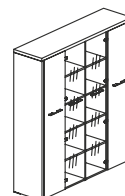

**SZAFKA 50H
DRZWI PŁYTOWE/SZKLANE**
PR6D2/S2 1720x450x1900 5 927,-

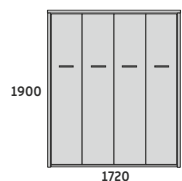

**SZAFKA 50H
DRZWI PŁYTOWE/SZKLANE**

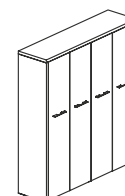

**SZAFKA 50H
DRZWI PŁYTOWE**
PR6D4 1720x450x1900 5 075,-

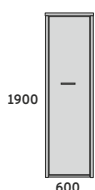

**SZAFKA 50H
UBRANIOWA**

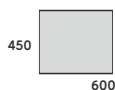

**SZAFKA 50H
UBRANIOWA**
PRSU 600x450x1900 2 125,-

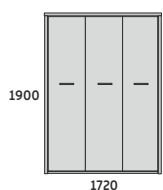

**SZAFKA 50H
UBRANIOWO-AKTOWA**

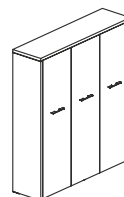

**SZAFKA 50H
UBRANIOWO-AKTOWA**
PR6SU3 1720x450x1900 4 731,-

moduł środkowy z wieszakiem suwanym, dwa skrajne moduły z półkami na segregatory

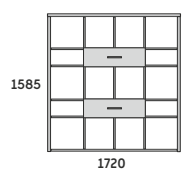

**SZAFKA 40H
SZUFLADY/REGAŁ**

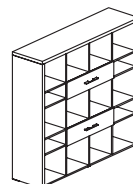

**SZAFKA 40H
SZUFLADY/REGAŁ**
PR5K 1720x450x1585 3 838,-

-TOP 39MM
-BOK 39MM
-PÓŁKI 18MM
-FRONTY DRZWI 18MM
-STOPKA ZE STALI 10MM

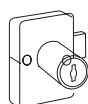

ZAMEK

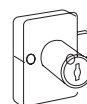

ZAMEK - KOMPLET
ZM 80,-

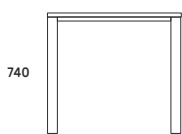

BIURKO SPATHIO

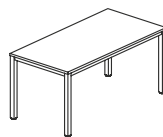

SPATHIO

SPB-01 1600x800x740	1 378,-
SPB-02 1900x900x740	1 449,-

BIURKO SPATHIO SZKLANA WSTAWKA

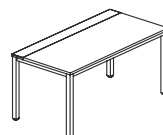
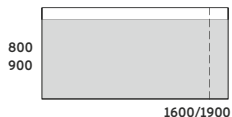

SPATHIO

SPBW-01 1600x800x740	1 610,-
SPBW-02 1900x900x740	1 805,-

BIURKO SPATHIO SZKLANA WSTAWKA PRZESUWANY BLAT

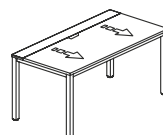
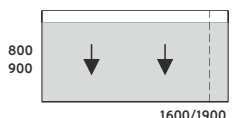

SPATHIO

SPB+S-01 1600x800x740	1 875,-
SPB+S-02 1900x900x740	2 070,-

BIURKO:
STELAŻ METALOWY: 50x50MM
BLAT BIURKA: 25MM
NOGA BIURKA: 39MM
BLENDY BIURKA: 18MM
REGULACJA POZIOMUJĄCA: +/- 10 MM

BIURKO Z SZAFKĄ

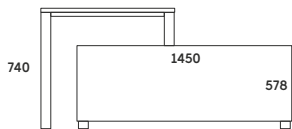

BIURKO SPATHIO PRAWIE

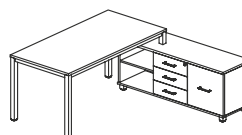
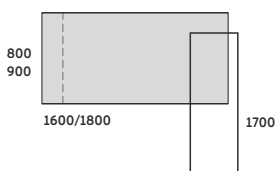

SPATHIO

SPB/SP-01P 1600x800x740	2 623,-
SPB/SP-02P 1900x900x740	2 734,-

BIURKO:
STELAŻ METALOWY: 50x50MM
BLAT BIURKA: 25MM
NOGA BIURKA: 39MM
REGULACJA POZIOMUJĄCA: +/- 10 MM

SZAFKA LEWA/PRAWA
WYMIARY 1450x450x578MM
KORPUS: 18MM
BLAT: 25MM
STOPKI METALOWE 50x50MM
REGULACJA POZIOMUJĄCA: +/- 10 MM
CICHY DOMYK W STANDARDZIE

BIURKO SPATHIO LEWE

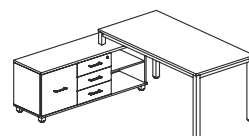
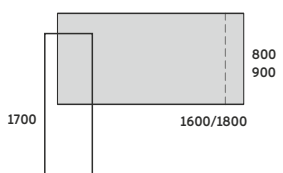

SPATHIO

SPB/SP-01L 1600x800x740	2 623,-
SPB/SP-02L 1900x900x740	2 734,-

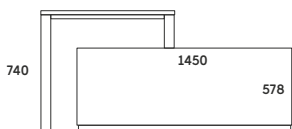

BIURKO SPATHIO PRAWIE

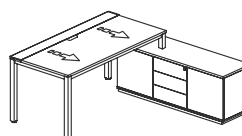
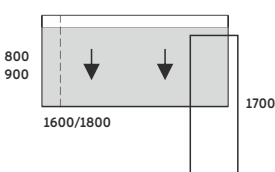

SPATHIO

SPB+S/SPC-01P 1600x800x740	3 704,-
SPB+S/SPC-02P 1900x900x740	4 071,-

BIURKO:
STELAŻ METALOWY: 50x50MM
BLAT 25MM - PRZESUWANY
SZKLANA WSTAWKA
NOGA BIURKA: 39MM
REGULACJA POZIOMUJĄCA: +/- 10 MM

SZAFKA LEWA/PRAWA WYMIARY
1450x450x578MM KORPUS: 18MM
BLAT: 25MM
PODSTAWA: COKÓŁ 30MM
OTWIERANIE: TIP-ON

BIURKO SPATHIO LEWE

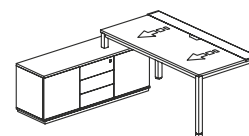
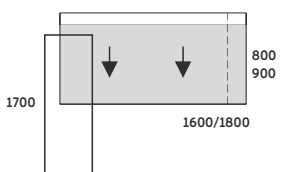

SPATHIO

SPB+S/SPC-01L 1600x800x740	3 704,-
SPB+S/SPC-02L 1900x900x740	4 071,-

BIURKO Z SZAFKĄ

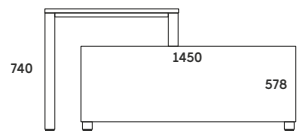

BIURKO SPATHIO PRAWO

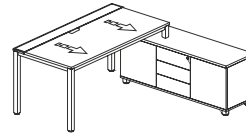
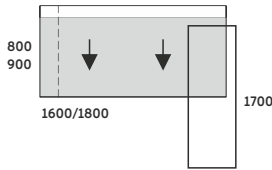

SPATHIO

SPB+S/SPN-01P 1600x800x740 3 808,-
SPB+S/SPN-02P 1900x900x740 4 163,-

BIURKO:
STELAŻ METALOWY: 50x50MM
BLAT 25MM - PRZESUWANY
SZKLANA WSTAWKA
NOGA BIURKA: 39MM
REGULACJA POZIOMUJĄCA: +/- 10 MM

BIURKO SPATHIO LEWO

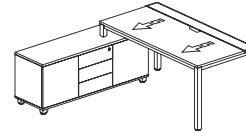
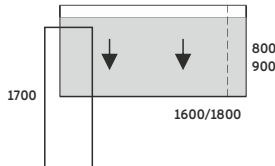

SPATHIO

SPB+S/SPN-01L 1600x800x740 3 808,-
SPB+S/SPN-02L 1900x900x740 4 163,-

SZAFKA LEWA/PRAWA WYMIARY
1450x450x578MM; KORPUS: 18MM
BLAT: 25MM
STOPKI METALOWE: 50x50MM
REGULACJA POZIOMUJĄCA: +/- 10 MM
OTWIERANIE: TIP-ON

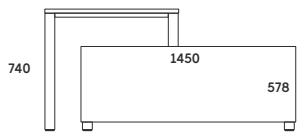

BIURKO SPATHIO PRAWO

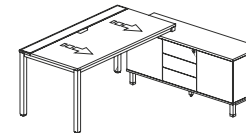
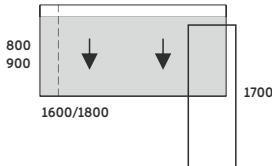

SPATHIO

SPB+S/SPS-01P 1600x800x740 3 764,-
SPB+S/SPS-02P 1900x900x740 4 142,-

BIURKO:
STELAŻ METALOWY: 50x50MM
BLAT 25MM - PRZESUWANY
SZKLANA WSTAWKA
NOGA BIURKA: 39MM
REGULACJA POZIOMUJĄCA: +/- 10 MM

BIURKO SPATHIO LEWO

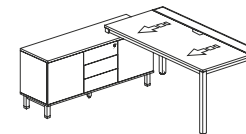
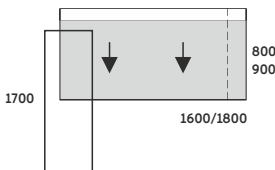

SPATHIO

SPB+S/SPS-01L 1600x800x740 3 764,-
SPB+S/SPS-02L 1900x900x740 4 142,-

SZAFKA LEWA/PRAWA WYMIARY
1450x450x578MM; KORPUS: 18MM
BLAT: 25MM
STELAŻ METALOWY: 50x50MM
REGULACJA POZIOMUJĄCA: +/- 10 MM
OTWIERANIE: TIP-ON

KONTENERY



KONTENER MOBILNY



KONTENER

SPK-01 430x600x550 877,-



KONTENER

SPK-02 430x600x550 767,-

-TOP 18MM
-KORPUS 18MM
-FRONTY SZUFLAD 18MM
-ZAMEK CENTRALNY
-CICHY DOMYK W STANDARDZIE



SZAFKA POMOCNIK



SZAFKA POMOCNIK

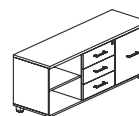

SZAFKA POMOCNIK

SPSP 1450x450x578 1 453,-

-TOP 25MM
-KORPUS 18MM
-FRONTY SZUFLAD 18MM
-ZAMEK CENTRALNY
-CICHY DOMYK W STANDARDZIE



DOSTAWKA SPATHIO

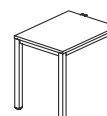

DOSTAWKA

DOSTAWKA SPATHIO

SPD 800x600x740 643,-

STELAŻ METALOWY: 50x50MM
BLAT: 25MM
REGULACJA POZIOMUJĄCA: +/- 10 MM

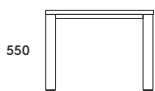

STOLIK NISKI SPATHIO

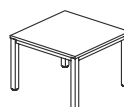
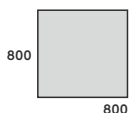

STOLIK NISKI SPATHIO
SP0 800x800x550 1 030,-



STÓŁ SPATHIO

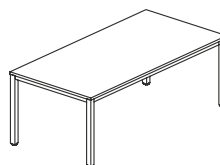

STÓŁ SPATHIO
SPS 2000x1000x740 1 402,-

PANEL FRONTOWY SPATHIO

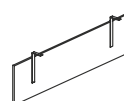
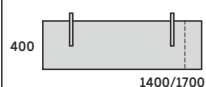

PANEL FRONTOWY SPATHIO
SPBL-01 1400x400x18 374,-
SPBL-02 1700x400x18 393,-

KORYTKO KABLOWE

ZALECA SIĘ ZASTOSOWANIE:
3 SZT. DO BIURKA 1600 MM
4 SZT. DO BIURKA 1900 MM

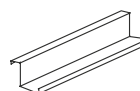

KORYTKO KABLOWE
KM-01 Długość: 400 115,-

REGAŁY SPATHIO

-KORPUS 18MM
-PÓŁKI 18MM

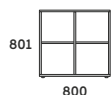

REGAŁ 20H



REGAŁ 20H
SP80R2 800x420x801 539,-

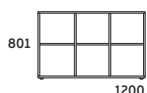

REGAŁ 20H

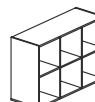

REGAŁ 20H
SP120R2 1200x420x801 723,-

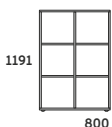

REGAŁ 30H

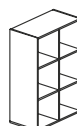

REGAŁ 30H
SP80R3 800x420x1191 763,-

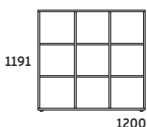

REGAŁ 30H

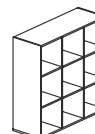
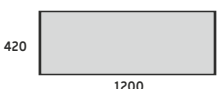

REGAŁ 30H
SP120R3 1200x420x1191 1 001,-

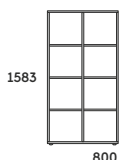

REGAŁ 40H

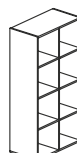

REGAŁ 40H
SP80R4 800x420x1583 993,-

-KORPUS 18MM
-PÓŁKI 18MM

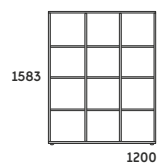

REGAŁ 40H

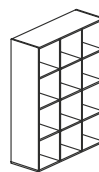

REGAŁ 40H
SP120R4 1200x420x1583 1 285,-

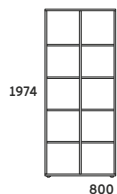

REGAŁ 50H

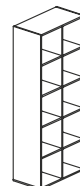

REGAŁ 50H
SP80R5 800x420x1974 1 214,-

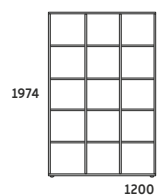

REGAŁ 50H

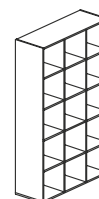

REGAŁ 50H
SP120R5 1200x420x1974 1 602,-

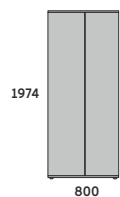

**SZAFU UBRANIOWA
50H**

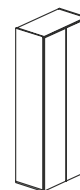

SZAFU UBRANIOWA

SZAFU UBRANIOWA 50H
SP80U 800x420x1974 1 468,-

-PŁYTA 18MM
-BEZ UCHWYTU



DRZWI PŁYTOWE 10H



DRZWI PŁYTOWE 10H
D10H 396x389x18 184,-



DRZWI PŁYTOWE 20H



DRZWI PŁYTOWE 20H
D20H 396x780x18 237,-

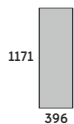

DRZWI PŁYTOWE 30H



DRZWI PŁYTOWE 30H
D30H 396x1171x18 292,-

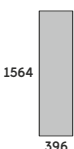

DRZWI PŁYTOWE 40H



DRZWI PŁYTOWE 40H
D40H 396x1564x18 351,-

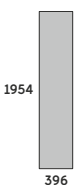

DRZWI PŁYTOWE 50H



DRZWI PŁYTOWE 50H
D50H 396x1954x18 394,-



DRZWI PŁYTOWE + SZKŁO 10H



**DRZWI PŁYTOWE
+SZKŁO 10H**
D10H+S 396x389x18 405,-

PODSTAWY DO REGAŁÓW

-STELAŻ 40X40 MM

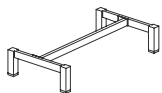

**STELAŻ 800
DO SZAF SPATHIO**

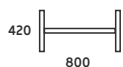

STELAŻ SPATHIO
USC800 800x420x150 438,-

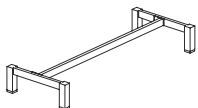

**STELAŻ 1200
DO SZAF SPATHIO**



STELAŻ SPATHIO
USC1200 1200x420x150 482,-

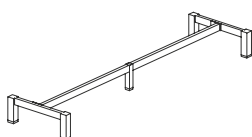

**STELAŻ 1600
DO SZAF SPATHIO**

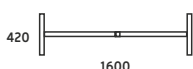

STELAŻ SPATHIO
USC1600 1600x420x150 519,-
na dwa regały o szerokości 800 mm

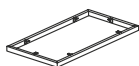

COKÓŁ SZAFY SPATHIO



**COKÓŁ METALOWY
SPATHIO**
CM-01 800x420x30 252,-
CM-03 1200x420x30 293,-

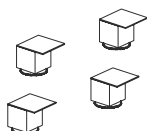

**NÓŻKI METALOWE
SZAFY SPATHIO 800**

**NÓŻKI METALOWE
SPATHIO**
NS50-4 50x50x50 196,-

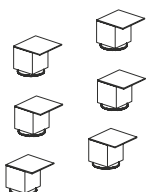

**NÓŻKI METALOWE
SZAFY SPATHIO 1200**

**NÓŻKI METALOWE
SPATHIO**
NS50-6 50x50x50 281,-

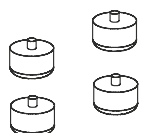

**NÓŻKI Z TWORZYWA
SZAFY SPATHIO 800**

**NÓŻKI Z TWORZYWA
SPATHIO**
AS30-4 Ø50x30 83,-

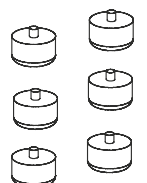

**NÓŻKI Z TWORZYWA
SZAFY SPATHIO 1200**

**NÓŻKI Z TWORZYWA
SPATHIO**
AS30-6 Ø50x30 123,-

-PŁYTA 25 MM



TOP 800

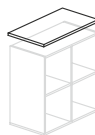
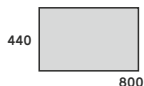

TOP 800
TS8 800x440x25 229,-

TOP 1200

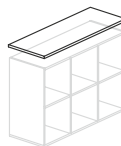

TOP 1200
TS12 1200x440x25 283,-

TOP 1600

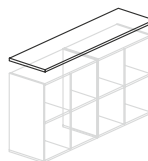

TOP 1600
TS16 1600x440x25 338,-

PŁYTA 25 MM

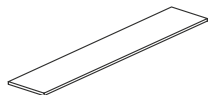

TOP 2400

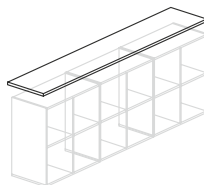

TOP 2400
TS24 2400x440x25 444,-
do dwóch regałów
o szerokości 1200 mm

-PŁYTA 18 MM + SZKŁO 6MM



TOP 800

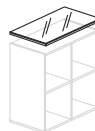
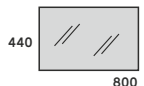

TOP 800
TS+S8 800x440x24 496,-

TOP 1200

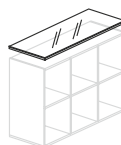

TOP 1200
TS+S12 1200x440x24 725,-

TOP 1600

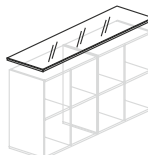
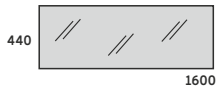

TOP 1600
TS+S16 1600x440x24 885,-



UCHWYT SPATHIO

UCHWYT

UCHWYT SPATHIO
US 128x15x15 38,-

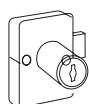

ZAMEK

ZAMEK

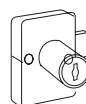

ZAMEK - KOMPLET
ZM 80,-

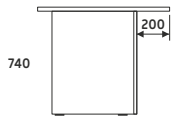

BLAT : 25MM
FRONT: 18MM

MODUŁ NISKI

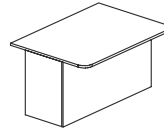
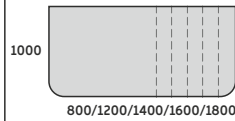

MODUŁ NISKI

SLPN-101	800x1000x740	1 222,-
SLPN-102	1200x1000x740	1 364,-
SLPN-103	1400x1000x740	1 421,-
SLPN-104	1600x1000x740	1 514,-
SLPN-105	1800x1000x740	1 600,-

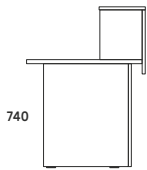

BLAT : 25MM
FRONT: 18MM
NADSTAWKA:
KORPUS 18MM
FRONT 18MM
BEZ OŚWIETLENIA
LUB Z OŚWIETLENIEM

MODUŁ WYSOKI BEZ OŚWIETLENIA / Z OŚWIETLENIEM

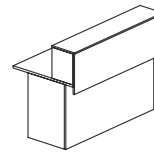
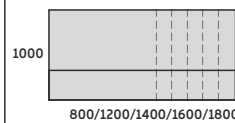

MODUŁ WYSOKI Z OŚWIETLENIEM

SLW-01/LED	800x820x740/1100	2 008,-
SLW-02/LED	1200x820x740/1100	2 131,-
SLW-03/LED	1400x820x740/1100	2 292,-
SLW-04/LED	1600x820x740/1100	2 428,-
SLW-05/LED	1800x820x740/1100	2 714,-

MODUŁ WYSOKI BEZ OŚWIETLENIA

SLW-01	800x820x740/1100	1 815,-
SLW-02	1200x820x740/1100	1 922,-
SLW-03	1400x820x740/1100	2 074,-
SLW-04	1600x820x740/1100	2 201,-
SLW-05	1800x820x740/1100	2 480,-

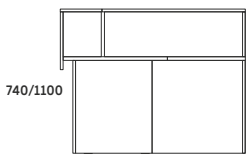

BLAT : 25MM
FRONT: 18MM
NADSTAWKA:
KORPUS 18MM
FRONT 18MM
BEZ OŚWIETLENIA
LUB Z OŚWIETLENIEM

MODUŁ NAROŻNY PRAWY BEZ OŚWIETLENIA / Z OŚWIETLENIEM

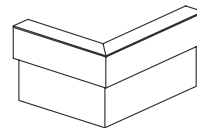
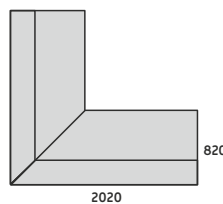

MODUŁ NAROŻNY PRAWY Z OŚWIETLENIEM

SLN P/LED 2020/1620x820x740/1100 5 449,-

MODUŁ NAROŻNY PRAWY BEZ OŚWIETLENIA

SLN P 2020/1620x820x740/1100 5 110,-

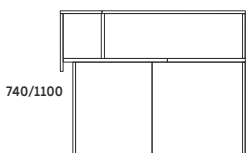

BLAT : 25MM
FRONT: 18MM
NADSTAWKA:
KORPUS 18MM
FRONT 18MM
BEZ OŚWIETLENIA
LUB Z OŚWIETLENIEM

MODUŁ NAROŻNY LEWY BEZ OŚWIETLENIA / Z OŚWIETLENIEM

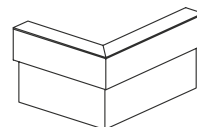
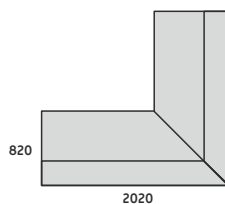

MODUŁ NAROŻNY LEWY Z OŚWIETLENIEM

SLN L/LED 2020/1620x820x740/1100 5 449,-

MODUŁ NAROŻNY LEWY BEZ OŚWIETLENIA

SLN L 2020/1620x820x740/1100 5 110,-

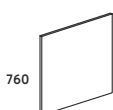

ZAKOŃCZENIE NISKIE PRAWY/LEWE

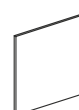

ZAKOŃCZENIE NISKIE P/L

SLKN P/L 820x25x760 260,-

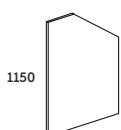

ZAKOŃCZENIE WYSOKIE PRAWY/LEWE



ZAKOŃCZENIE WYSOKIE P/L

SLKW P/L 820x25x1150 363,-

BOK: 25MM

ZESTAW PODŁĄCZENIOWY

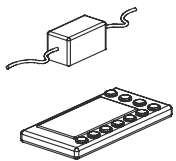

STEROWNIK LED
ZASILACZ 230V
PILOT

ZESTAW PODŁĄCZENIOWY LED

DO KAŻDEGO ZESTAWU LAD
Z OŚWIECENIEM NALEŻY DODAC
ZESTAW POŁĄCZENIOWY

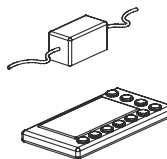

ZESTAW PODŁĄCZENIOWY LED ZLED

469,-

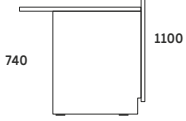

MODUŁ WYSOKI MELAMINA/AKRYL

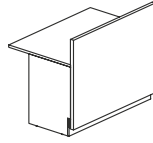
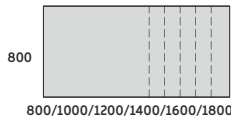

MODUŁ WYSOKI MELAMINA

UIW-01 800x800x740/1000	1 720,-
UIW-02 1000x800x740/1000	1 963,-
UIW-03 1200x800x740/1000	2 163,-
UIW-04 1400x800x740/1000	2 362,-
UIW-05 1600x800x740/1000	2 604,-
UIW-06 1800x800x740/1000	2 850,-

MODUŁ WYSOKI AKRYL

UIW-01 800x800x740/1000	2 432,-
UIW-02 1000x800x740/1000	2 748,-
UIW-03 1200x800x740/1000	3 216,-
UIW-04 1400x800x740/1000	3 571,-
UIW-05 1600x800x740/1000	3 970,-
UIW-06 1800x800x740/1000	4 373,-

BLAT : 25MM
FRONT: 25MM Z MELAMINY
FRONT: 37MM Z AKRYLU
OŚWIETLENIE LED

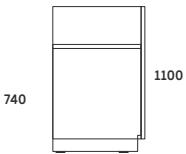

DOSTAWKA PRAWA/LEWA MELAMINA/AKRYL

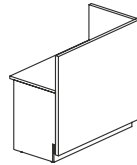
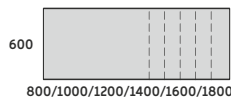

DOSTAWKA PRAWA/LEWA MELAMINA

UID-01 P/L 800x600x740/1000	2 222,-
UID-02 P/L 1000x600x740/1000	2 403,-
UID-03 P/L 1200x600x740/1000	2 621,-
UID-04 P/L 1400x600x740/1000	2 832,-
UID-05 P/L 1600x600x740/1000	2 953,-
UID-06 P/L 1800x600x740/1000	3 137,-

DOSTAWKA PRAWA/LEWA AKRYL

UID-01 P/L 800x600x740/1000	3 357,-
UID-02 P/L 1000x600x740/1000	3 761,-
UID-03 P/L 1200x600x740/1000	4 100,-
UID-04 P/L 1400x600x740/1000	4 444,-
UID-05 P/L 1600x600x740/1000	4 780,-
UID-06 P/L 1800x600x740/1000	5 121,-

BLAT : 25MM
FRONT: 25MM Z MELAMINY
FRONT: 37MM Z AKRYLU
OŚWIETLENIE LED

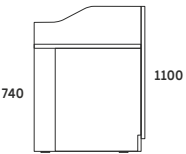

MODUŁ NAROŻNY 1 FALA PRAWY/LEWY MELAMINA/AKRYL

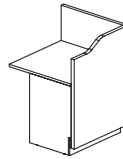
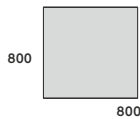

MODUŁ NAROŻNY 1 FALA MELAMINA

UIN-01 P/L 800x800x740/1000	2 664,-
-----------------------------	---------

MODUŁ NAROŻNY 1 FALA AKRYL

UIN-01 P/L 800x800x740/1000	4 082,-
-----------------------------	---------

BLAT : 25MM
FRONT: 25MM Z MELAMINY
FRONT: 37MM Z AKRYLU
OŚWIETLENIE LED

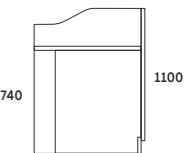

MODUŁ NAROŻNY 2 FALE PRAWY/LEWY MELAMINA/AKRYL

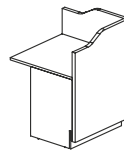
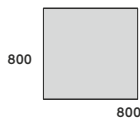

MODUŁ NAROŻNY 2 FALE MELAMINA

UIN-02 P/L 800x800x740/1000	2 777,-
-----------------------------	---------

MODUŁ NAROŻNY 2 FALE AKRYL

UIN-02 P/L 800x800x740/1000	4 158,-
-----------------------------	---------

BLAT : 25MM
FRONT: 25MM Z MELAMINY
FRONT: 37MM Z AKRYLU
OŚWIETLENIE LED

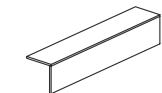

NADSTAWKA NISKA BEZ OŚWIETLENIA/ Z OŚWIETLENIEM

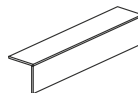
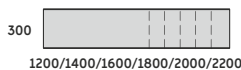

NADSTAWKA NISKA Z OŚWIETLENIEM

UINN-01/LED 1200x300x300	859,-
UINN-02/LED 1400x300x300	912,-
UINN-03/LED 1600x300x300	998,-
UINN-04/LED 1800x300x300	1 084,-
UINN-05/LED 2000x300x300	1 154,-
UINN-06/LED 2200x300x300	1 256,-

NADSTAWKA NISKA BEZ OŚWIETLENIA

UINN-01 1200x300x300	590,-
UINN-02 1400x300x300	645,-
UINN-03 1600x300x300	716,-
UINN-04 1800x300x300	806,-
UINN-05 2000x300x300	861,-
UINN-06 2200x300x300	949,-

BLAT : 18MM
FRONT: 18MM
Z OŚWIETLENIEM
BEZ OŚWIETLENIA LED

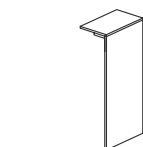

NADSTAWKA WYSOKA BEZ OŚWIETLENIA/ Z OŚWIETLENIEM



NADSTAWKA WYSOKA Z OŚWIETLENIEM

UINW/LED 500x300x1100	890,-
-----------------------	-------

NADSTAWKA WYSOKA BEZ OŚWIETLENIA

UINW 500x300x1100	576,-
-------------------	-------

BLAT : 18MM
FRONT: 18MM
Z OŚWIETLENIEM
BEZ OŚWIETLENIA LED

ZESTAW PODŁĄCZENIOWY

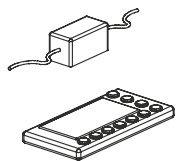

STEROWNIK LED
ZASILACZ 230V
PILOT

ZESTAW PODŁĄCZENIOWY LED

DO KAŻDEGO ZESTAWU LAD
Z OŚWIETLENIEM NALEŻY DODAC
ZESTAW POŁĄCZENIOWY

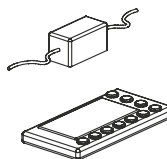

ZESTAW PODŁĄCZENIOWY LED
ZLED 469,-



System meble biurowe
biuro@systemmeble.pl
www.systemmeble.pl
tel. 790 536 205

**Wykonujemy efektywne miejsca
pracy na terenie całego kraju**

POLMARCO

www.polmarco.pl biuro@polmarco.pl